

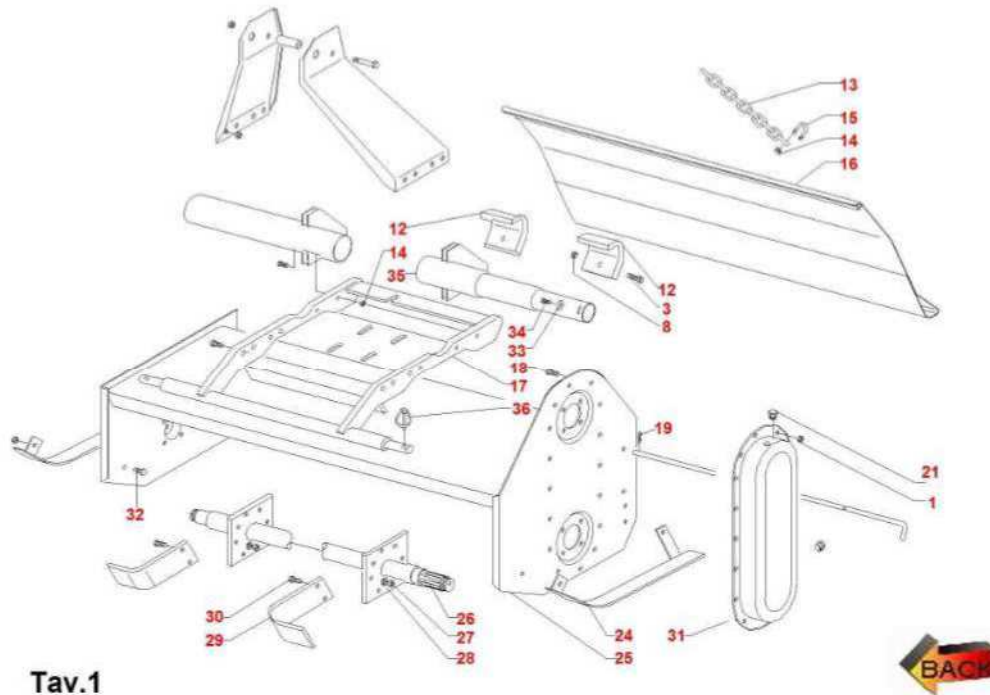

















F1T1



Tav.1

			CODICE	Descrizione	Q.tà Nota
1			DAG00101	DADO AUTOBL. 982 C.8 10X1,5 MA ZIN. B.	1
3			VIT02601	VITE TE 8.8 12X40 NERA UNI 5739 DIN 933	1
12			F1045011	STAFFA FISSAGGIO ATT.3P ZAPPATRICI F1-F2	1
13			CAT00401	CATENA COFANO V 82	1
14			DAG01701	DADO AUTOBL. 982 C.8 8X1,25 MA ZIN,B	1
15			SPC03401	MORSETTO SERRAFILO PER FUNE DA 10	1
16			F1054010	COFANO POSTERIORE F1-85 FINITO	1
16			F1055010	COFANO POSTERIORE F1-105 FINITO	1
16			F1056010	COFANO POSTERIORE F1-125 FINITO	1
16			F1057010	COFANO POSTERIORE F1-145 FINITO	1
17			F1034010	BASAMENTO ATTACCO TRE PUNTI F1 COMPLETO	1
18			VIT00201	VITE TE 8,8 M 10X20 UNI 5739 DIN 933	1
19			SPC00401	COPPIGLIA A MOLLA D,3	1







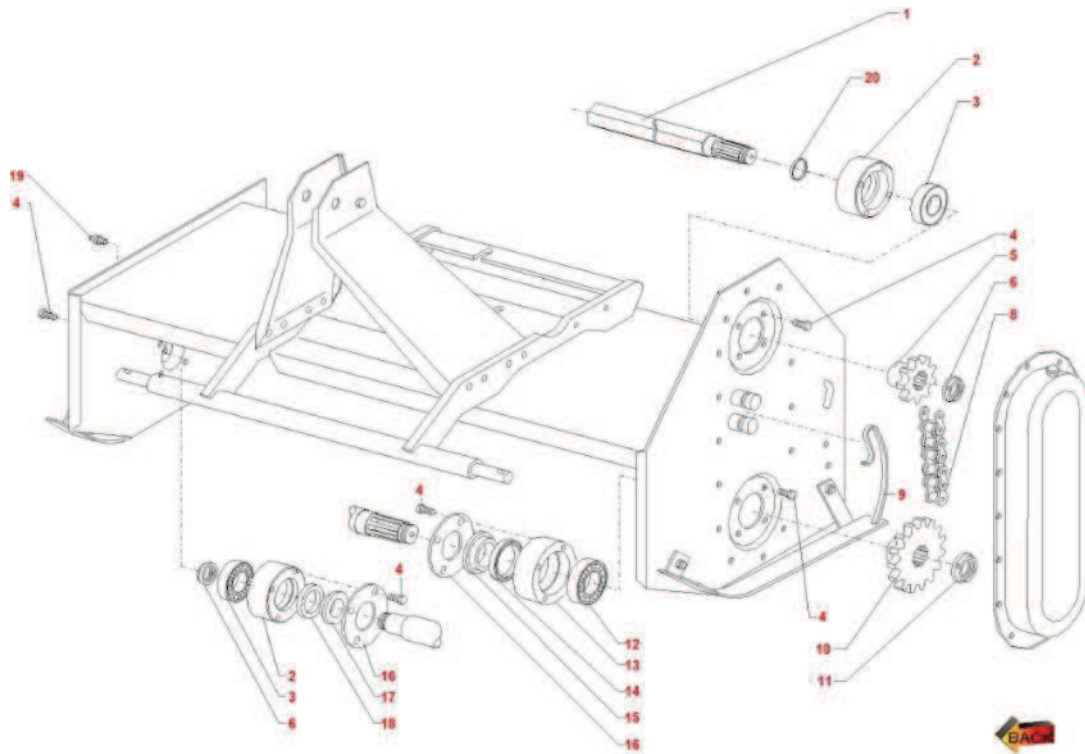

21		TAP00501	TAPPO DI CARICO CON SFIATO 3/8" GAS	1
24		F1090010	SLITTA DI SUPPORTO F1 DESTRA	1
25		F1027011	TELAIO COMPLETO F1 085	1
25		F1028011	TELAIO COMPLETO F1 105	1
25		F1029011	TELAIO COMPLETO F1 125	1
25		F1030011	TELAIO COMPLETO F1 145	1
26		F1017011	ROTORE COMPLETO F1 85	1
26		F1018011	ROTORE COMPLETO F1 105	1
26		F1019011	ROTORE COMPLETO F1 125	1
26		F1020011	ROTORE COMPLETO F1 145	1
27		DAG01801	DADO M 12X1,25 ALTO 8,8 UNI 5587 ZINCATO	1
28		RON01101	GROWER PESANTE M12 ZINCATA	1
29		F1060010	ZAPPA VIRGOLA PER F1 60X6 DX	1
30		VIT02721	VITE TE 8,8 M 12X1,25X35 ZINC.	1
31		F1003711	CARTER CATENA F1 GREZZO	1
32		VIT00311	VITE TE 8,8 5739 10X30 ZINCATA	1
33		F1070010	RONDELLA FISSAGGIO TUBO TELESCOPICO	1
34		VIT00221	VITE TE 8,8 10X1,25X20 UNI 5740 NERA	1
35		F1086010	PROTEZIONE TELESCOPICA COMPLETA F1 85	1
35		F1087010	PROTEZIONE TELESCOPICA COMPLETA F1 105	1
35		F1088010	PROTEZIONE TELESCOPICA COMPLETA F1 125	1
35		F1089010	PROTEZIONE TELESCOPICA COMPLETA F1 145	1
36		SPC01501	SPINA A SCATTO D. 10	1



F1T2



		CODICE	Descrizione	Q.tà Nota
1		F1008011	ESAGONO TRASMISSIONE F1-85	1
1		F1009011	ESAGONO TRASMISSIONE F1-105	1
1		F1010011	ESAGONO TRASMISSIONE F1-125	1
1		F1011011	ESAGONO TRASMISSIONE F1-145	1
2		F1002010	FLANGIA LATO OPPOSTO F1/F2 E SUPERIORE F1	1
3		CUS03101	CUSCINETTO 6207 2RS MARCA ZKL	1
4		VIT00221	VITE TE 8.8 10X1,25X20 UNI 5740 NERA	1
5		F1003010	PIGNONE 1" ASA 80 Z=9 MAT. C40 BONIFICATO	1
6		DAG01201	GHIERA AUTOBL. GUK 30X1,5	1
8		F1003210	CATENA ASA 80H 36P. A.C. RIB.	1
9		F1003510	TENDITORE A MOLLA D.6	1
10		F1004010	PIGNONE 1" ASA 80 Z15 (SOST. DA COD. F1004020)	1
11		DAG01501	GHIERA AUTOBL. GUK 35X1,5	1







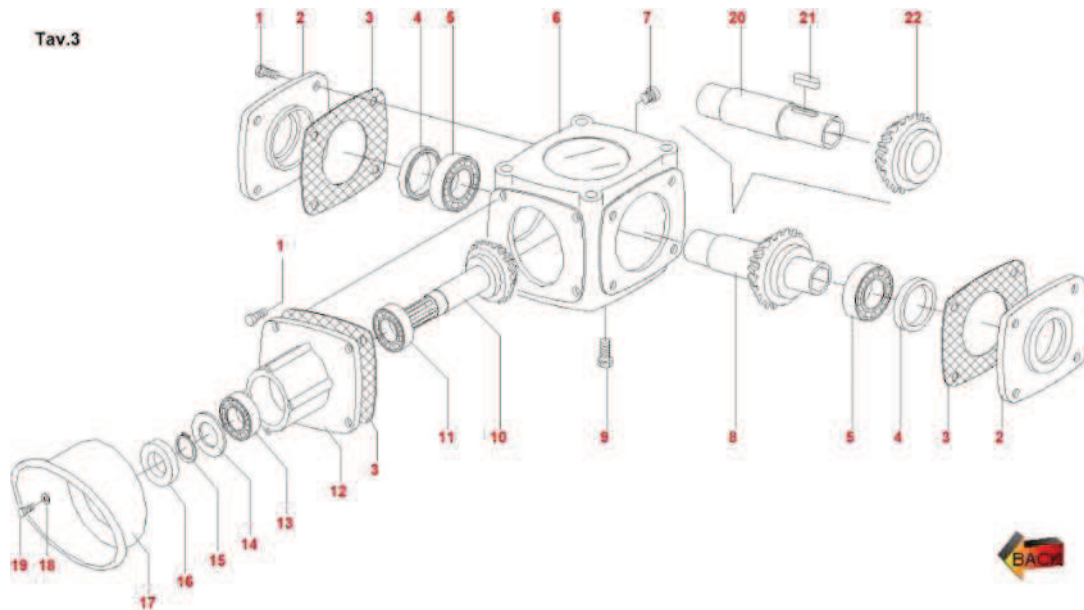

12		CUS02621	CUSCINETTO 6208 MARCA ZKL	1
13		F1001010	FLANGIA LATO TRASMISSIONE F1	1
14		GUA07301	ANELLO DI TENUTA 60X75X8 TC - BASL	1
15		F1005010	DISTANZIALE LATO TRASMISSIONE F1	1
16		F1006510	DISCO DI PROTEZIONE FLANGIA INFERIORE	1
17		F1006010	DISTANZIALE LATO RINVIO F1	1
18		GUA01001	ANELLO DI TENUTA 42X55X8 BA	1
19		VLD00201	INGRASSATORE DIRITTO 8X1,25 MA AMA 278/A	1
20		F1007510	DISTANZIALE ESAGONO TRASMISSIONE F1	1



F1T3



		CODICE	Descrizione	Q.tà Nota
1		VIT03201	VITE TE 8.8 M 12X25 UNI 5739 NERA	1
2		RO210101	COPERCHIO TB19C	1
3		GUA09001	GUARNIZIONE COPERCHIO TB19C	1
4		GUA07201	ANELLO DI TENUTA 50X65X8	1
5		CUS03001	CUSCINETTO 6010	1
6		RO210501	SCATOLA TB19C	1
7		TAP00401	TAPPO CON ESAGONO 3/8" GAS CIECO	1
8		RO211201	CANNOTTO CON CORONA TB19C	1
9		VIT00501	VITE TE M 12X30 UNI 5739 DIN 933	1
10		RO210901	ALBERO-PIGNONE DI ENTRATA TB19C	1
11		CUS00701	CUSCINETTO 30207 MARCA KOYO	1
12		RO211001	PROLUNGA TB19C	1
13		CUS01301	CUSCINETTO 6207 2Z MARCA ZKL	1

14		ANS01101	SPESSORE 35-55	1
15		ANS02601	ANELLO SEEGER E 35 DIN 471	1
16		GUA06001	ANELLO DI TENUTA 35X72X10 BASL	1
17		GUP00301	CONTROCUFFIA GRANDE OVALE D.280 CON 2 APERTURE	1
18		RON00101	RONDELLA DI=9 DE=24	1
19		VIT04501	VITE TE 8.8 5739 8X16 ZINCATA	1
20		RO210601	CANNOTTO TB19C	1
21		SPC01201	LINGUETTA 12X8X28	1
22		RO210801	CORONA Z.19	1