



Spider 1800 - N. 31986

CATALOGO PARTI DI RICAMBIO
SPARE PARTS CATALOGUE
CATALOGUE PIECES DE RECHANGE
ERSATZTEILLISTE
CATÁLOGO PARTES DE REQUESTO

Spider 1300 • 1500 • 1800

per ordinare i pezzi di ricambio

Per una corretta ordinazione dei pezzi di ricambio è necessario indicare i seguenti elementi:

- 1) Modello della macchina,
 - 2) Numero di catalogo,
 - 3) Codice del ricambio,
 - 4) Quantità richiesta.
-

pour commander les pièces de rechange

Pour commander les pièces de rechange il faut indiquer:

- 1) Modèle de la machine,
 - 2) Nombre du catalogue,
 - 3) Code de la pièce de rechange,
 - 4) Quantité demandé.
-

to order the spare parts

To order the spare parts correctly you must specify:

- 1) Model of the machine,
 - 2) Catalogue number,
 - 3) Spare part code number,
 - 4) Required quantity.
-

um die Ersatzteile zu bestellen

Für eine korrekte Bestellung der Ersatzteilen müssen die folgende Einzelheiten angegeben werden:

- 1) Gerät-Modell,
 - 2) Katalog-Nummer,
 - 3) Teil-Nummer,
 - 4) Gewünschte Menge.
-

para pedir las partes de requesto

Para pedir correctamente las partes de requesto se tiene que especificar:

- 1) Modelo de la máquina,
- 2) Número de catálogo,
- 3) Código de la parte de requesto,
- 4) Cantidad pedida.

TAV. 1436

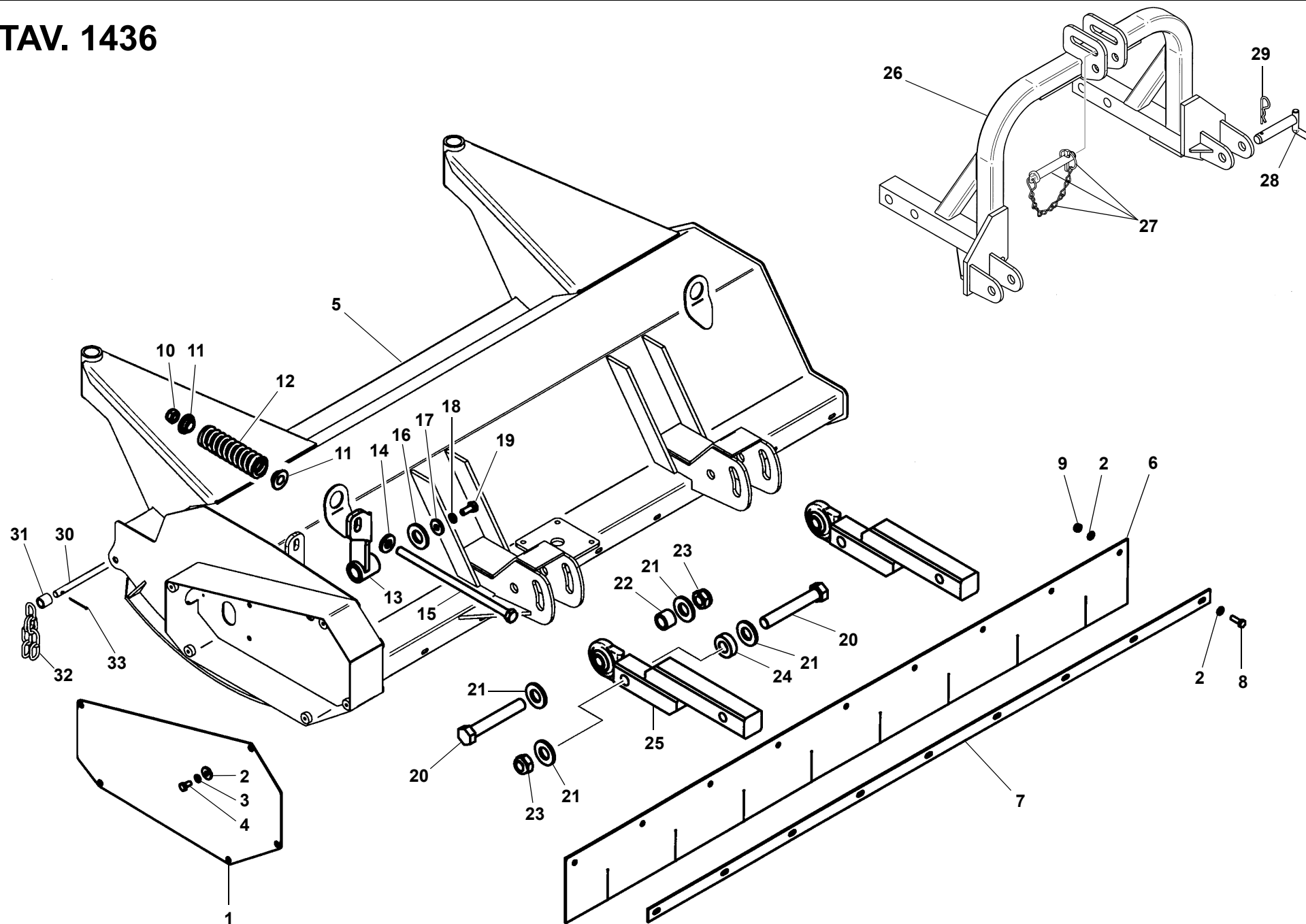

TAV. 1436

RIF.	CODICE	DESCRIZIONE	N.
1	3009822		1
2	1309243	ø8x24x3 Spider 1300	37
	1309243	ø8x24x3 Spider 1500	41
	1309243	ø8x24x3 Spider 1800	49
3	1508150	ø8 UNI6798A	5
4	1110804	M8x16 UNI5739	5
5	3009852	Spider 1300	1
	3009801	Spider 1500	1
	3010007	Spider 1800	1
6	3009502	Spider 1300	2
	3009503	Spider 1500	2
	3010009	Spider 1800	2
7	3009504	Spider 1300	2
	3009505	Spider 1500	2
	3010008	Spider 1800	2
8	1110808	M8x25 UNI5739 Spider 1300	16
	1110808	M8x25 UNI5739 Spider 1500	18
	1110808	M8x25 UNI5739 Spider 1800	22
9	1012408	M8 UNI7474 Spider 1300	16
	1012408	M8 UNI7474 Spider 1500	18
	1012408	M8 UNI7474 Spider 1800	22
10	1012414	M14 UNI7474	1
11	3001093		2
12	3004156		1
13	3008550		1
14	3001118	ø14,5x35x5	1

RIF.	CODICE	DESCRIZIONE	N.
15	3004948		1
16	1124000	ø24 UNI6592	1
17	1410304	ø10,5x30x4	1
18	1210000	ø10 UNI1751	1
19	1111010	M10x30 UNI5739	1
20	1102254	M22x140 UNI5737	4
21	3000178		8
22	3009823		2
23	1012422	M22 UNI7474	4
24	3009827		2
25	3009814		2
26	3009878		1
27	3000447		1
28	3000448		2
29	0002115	ø4	2
30	3007365	Spider 1300	1
	3007366	Spider 1500	1
	3007821	Spider 1800	1
31	3001545	Spider 1300	39
		Spider 1500	45
		Spider 1800	53
32	3001475	Spider 1300	43
		Spider 1500	50
		Spider 1800	59
33	1559028	4,5X45 UNI 1336	1

RIF.	CODICE	DESCRIZIONE	N.

TAV. 1436

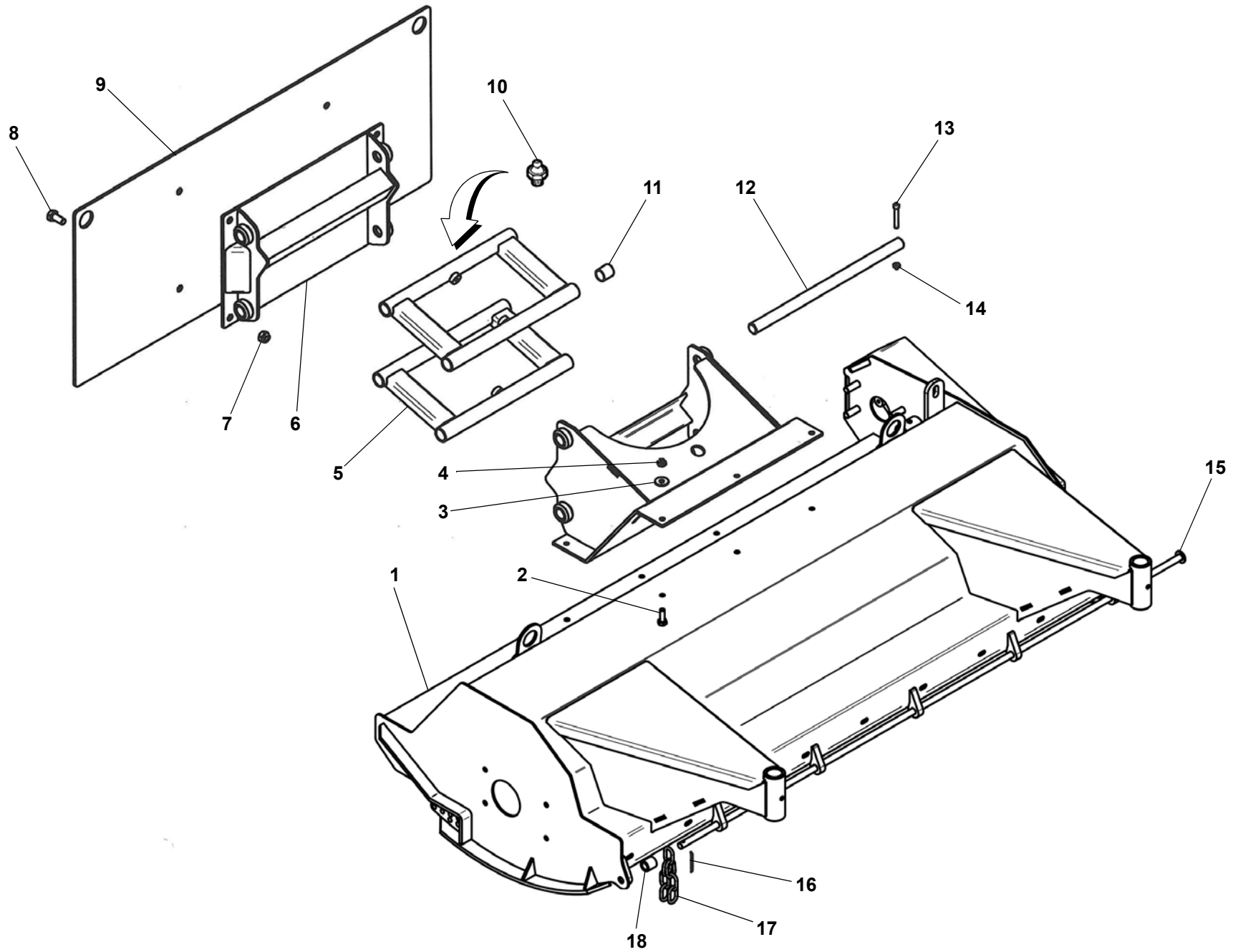

TAV. 1436

RIF.	CODICE	DESCRIZIONE	N.
1	3015886	Spider 1300	1
	3015887	Spider 1500	1
	3018274	Spider 1800	1
2	1111010	M10x30 UNI5739	6
3	1310303	ø10 UNI6593	6
4	1012410	M10 UNI7474	6
5	3011839		2
6	3011846		1
7	1012414	M14 UNI7474	4
8	1111410	M14x30 UNI5739	4
9	3011881		1
10	0002654	M10x1	4
11	0001490	KU 25x28x30	8
12	3011847		4
13	1120820	M8x55 UNI5931	4
14	1012408	M8 UNI7474	4
15	3007365	Spider 1300	1
	3007366	Spider 1500	1
	3007821	Spider 1800	1
16	1559028	ø4,5x45 UNI1336	1
17	3001475	Spider 1300	43
	3001475	Spider 1500	50
	3001475	Spider 1800	59
18	3001545	Spider 1300	39
	3001545	Spider 1500	45
	3001545	Spider 1800	53

RIF.	CODICE	DESCRIZIONE	N.

RIF.	CODICE	DESCRIZIONE	N.

TAV. 1437

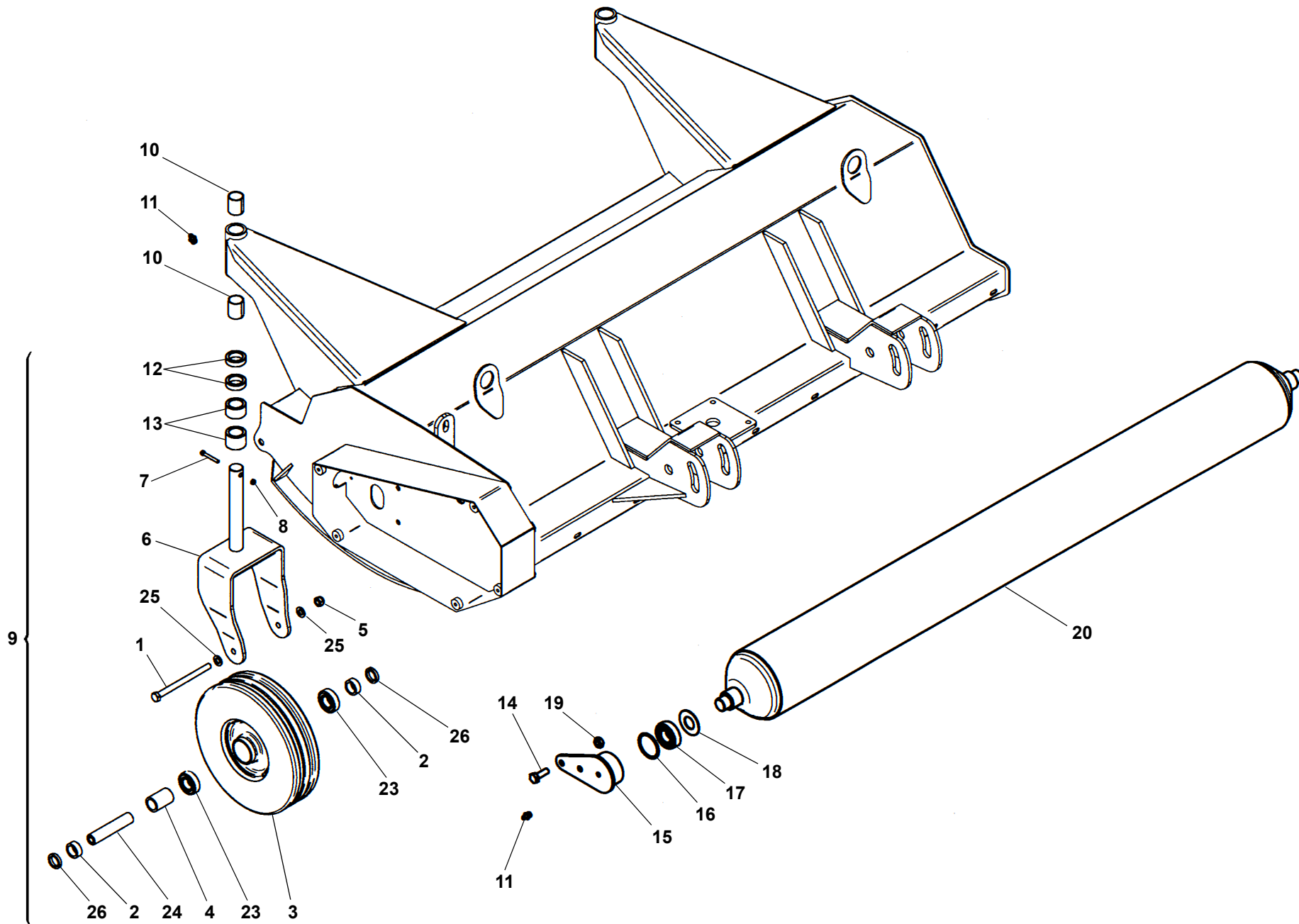

TAV. 1437

RIF.	CODICE	DESCRIZIONE	N.
1	1101262	M12x160 UNI5737	1
2	2400093		2
3	2600022		1
4	2400090		1
5	1011712	M12 DIN 980	1
6	3011513		1
7	1120616	M6x45 UNI5931	1
8	1012406	M6 UNI7474	1
9	8981009		2
10	0001489	KU 30x34x40	4
11	0002654	M10x1	4
12	3009686	H=12,5	2
13	3009685	H=25	2
14	1111014	M10x40 UNI5739	4
15	3002717		2
16	3000180	45x51,5x1,5	2
17	0001411	6205-2RS	2
18	3000486		2
19	1012410	M10 UNI7474	4
20	3000429	Spider 1300	1
	3002715	Spider 1500	1
	3007784	Spider 1800	1
23	0001411	6205-2RS	2
24	2400091		1
25	1112000	ø12 UNI6592	2
26	2400092		2

RIF.	CODICE	DESCRIZIONE	N.

RIF.	CODICE	DESCRIZIONE	N.

TAV. 1438

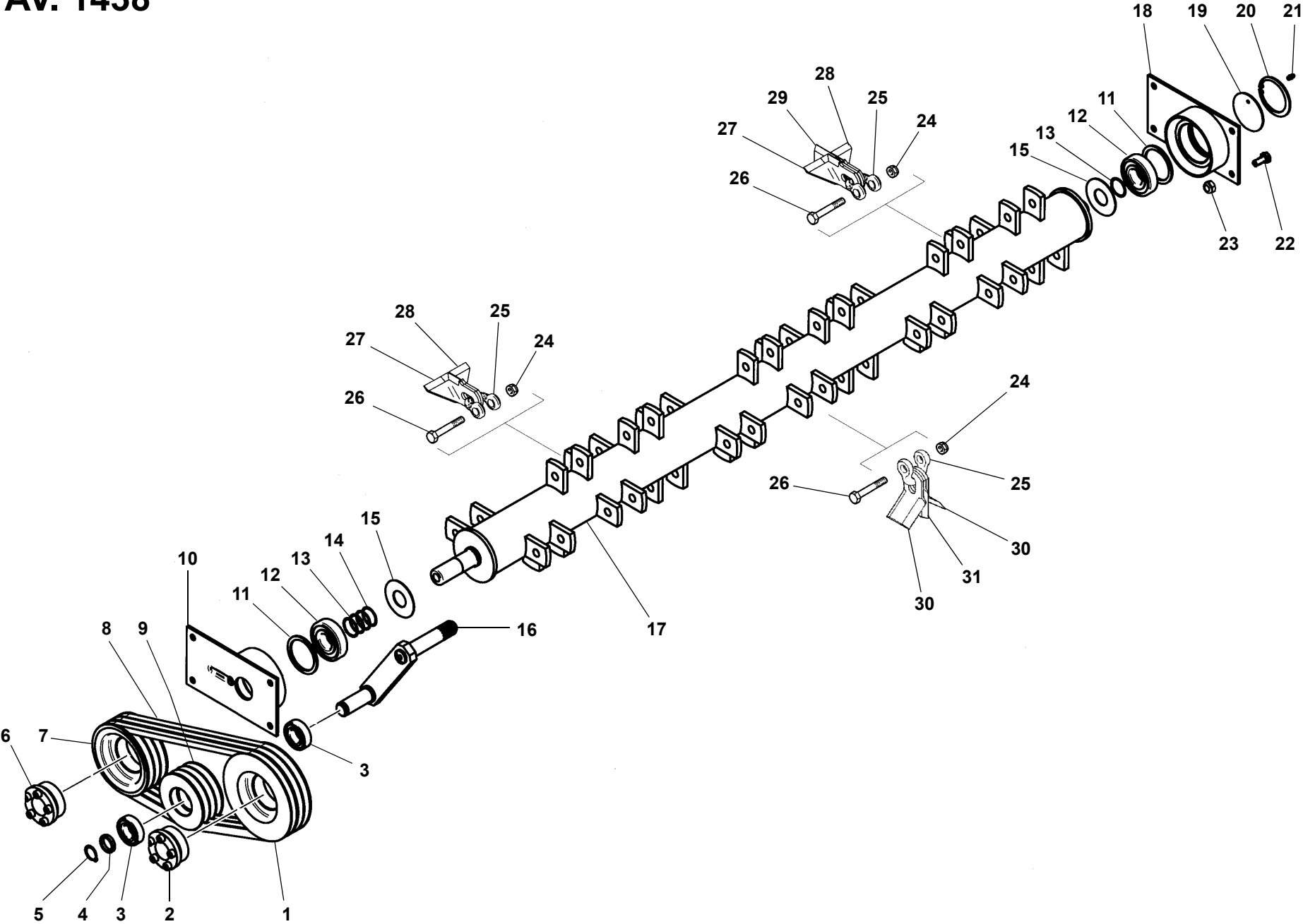

TAV. 1438

RIF.	CODICE	DESCRIZIONE	N.
1	3009479	160x3 SPA Spider 1300-1500	1
	3009479	160x3 SPA Spider 1800	1
2	0001342	35x65	1
3	0001496	6205-2RS	2
4	3009826		1
5	1010025	Seeger E 25 UNI7435	1
6	0001353	30x65	1
7	3008357	130x3 SPA Spider 1300-1500	1
	3008357	130x3 SPA Spider 1800	1
8	0001035	SPA-X 1207	3
9	3009825		1
10	3000979	Sx Spider 1300-1500	1
	3012989	Sx Spider 1800	1
11	3000640	58,5x71x3	2
12	0001421	1306	2
13	3008972	30,5x42x1,5	3
14	3008971	30,5x42x1	—
15	3000648		2
16	3009564		1
17	3007253	Spider 1300	1
	3007327	Spider 1500	1
	3012987	Spider 1800	1
18	3000978	Dx Spider 1300-1500	1
	3012988	Dx Spider 1800	1
19	3000990		1
20	1020072	Seeger I 72 UNI7437	1

RIF.	CODICE	DESCRIZIONE	N.
21	0002659	M6	1
22	1111006	M10x20 UNI5739	8
23	1012410	M10 UNI7474	8
24	1012414	M14 UNI7474 Spider 1300	16
	1012414	M14 UNI7474 Spider 1500-1800	24
25	3005676	Spider 1300	16
	3005676	Spider 1500-1800	24
26	3006825	M14x90 12.9 Spider 1300	16
	3006825	M14x90 12.9 Spider 1500-1800	24
27	3009688	Sx Spider 1300	16
	3009688	Sx Spider 1500-1800	24
28	3009687	Dx Spider 1300	16
	3009687	Dx Spider 1500-1800	24
29	3009689	Spider 1300	16
	3009689	Spider 1500-1800	24
30	3005674	Spider 1300	32
	3005674	Spider 1500-1800	48
31	3005675	Spider 1300	16
	3005675	Spider 1500-1800	24

RIF.	CODICE	DESCRIZIONE	N.

TAV. 1439

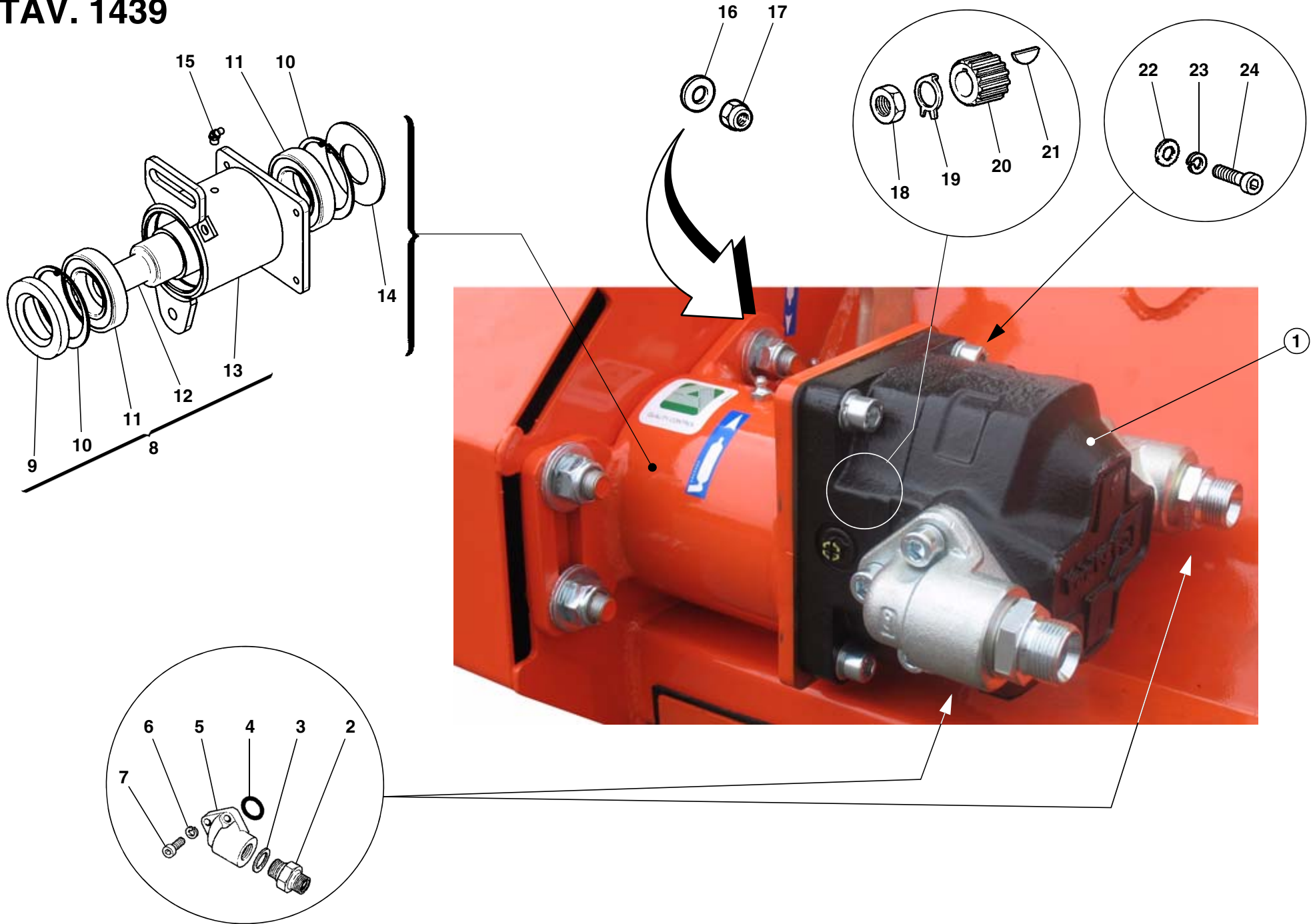

TAV. 1439

RIF.	CODICE	DESCRIZIONE	N.
1	0004195		1
2	0002306	3/4"	2
3	0002026	3/4"	2
4	0001701	OR 132	2
5	0002402	3/4"x51	2
6	1208000	ø8 UNI1751	6
7	1120808	M8x25 UNI5931	6
8	3010904		1
9	0001831	55x100x13	1
10	1020100	Seeger I 100 UNI7437	2
11	0001488	6211-2RS	2
12	3007773		1
13	3010903		1
14	3004762		1
15	0002653	M10x1x45°	1
16	3001118	14,5x35x5	3
17	1012414	M14 UNI7474	3
18	1021514	M14x1,5 UNI5589	1
19	0002986		1
20	0002917		1
21	1551007	4x7,5x18,57 UNI6606	1
22	1110000	ø10 UNI6592	4
23	1210000	ø10 UNI1751	4
24	1121014	M10x40 UNI5931	4

RIF.	CODICE	DESCRIZIONE	N.
------	--------	-------------	----

RIF.	CODICE	DESCRIZIONE	N.
------	--------	-------------	----

