

UT-UT F



UT Super
UT F Super

TESTATE IDRAULICHE
TÊTES HYDRAULIQUES-HYDRAULISCHE KÖPFE
HYDRAULIC HEADS-CABEZAS HIDRÁULICAS



UT 150

UT 100 S - N. 73788
Ölmenge 60 l/min



CATALOGO PARTI DI RICAMBIO
SPARE PARTS CATALOGUE
CATALOGUE PIÈCES DE RECHANGE
ERSATZTEILLISTE
CATÁLOGO PARTES DE REQUESTO

UT - UT F

UT Super - UT F Super

per ordinare i pezzi di ricambio

Per una corretta ordinazione dei pezzi di ricambio è necessario indicare i seguenti elementi:

- 1) Modello della macchina,
 - 2) Numero di catalogo,
 - 3) Codice del ricambio,
 - 4) Quantità richiesta.
-

pour commander les pièces de rechange

Pour commander les pièces de rechange il faut indiquer:

- 1) Modèle de la machine,
 - 2) Nombre du catalogue,
 - 3) Code de la pièce de rechange,
 - 4) Quantité demandé.
-

to order the spare parts

To order the spare parts correctly you must specify:

- 1) Model of the machine,
 - 2) Catalogue number,
 - 3) Spare part code number,
 - 4) Required quantity.
-

um die Ersatzteile zu bestellen

Für eine korrekte Bestellung der Ersatzteilen müssen die folgende Einzelheiten angegeben werden:

- 1) Gerät-Modell,
 - 2) Katalog-Nummer,
 - 3) Teil-Nummer,
 - 4) Gewünschte Menge.
-

para pedir las partes de requesto

Para pedir correctamente las partes de requesto se tiene que especificar:

- 1) Modelo de la máquina,
- 2) Número de catálogo,
- 3) Código de la parte de requesto,
- 4) Cantidad pedida.

TAV. 1386

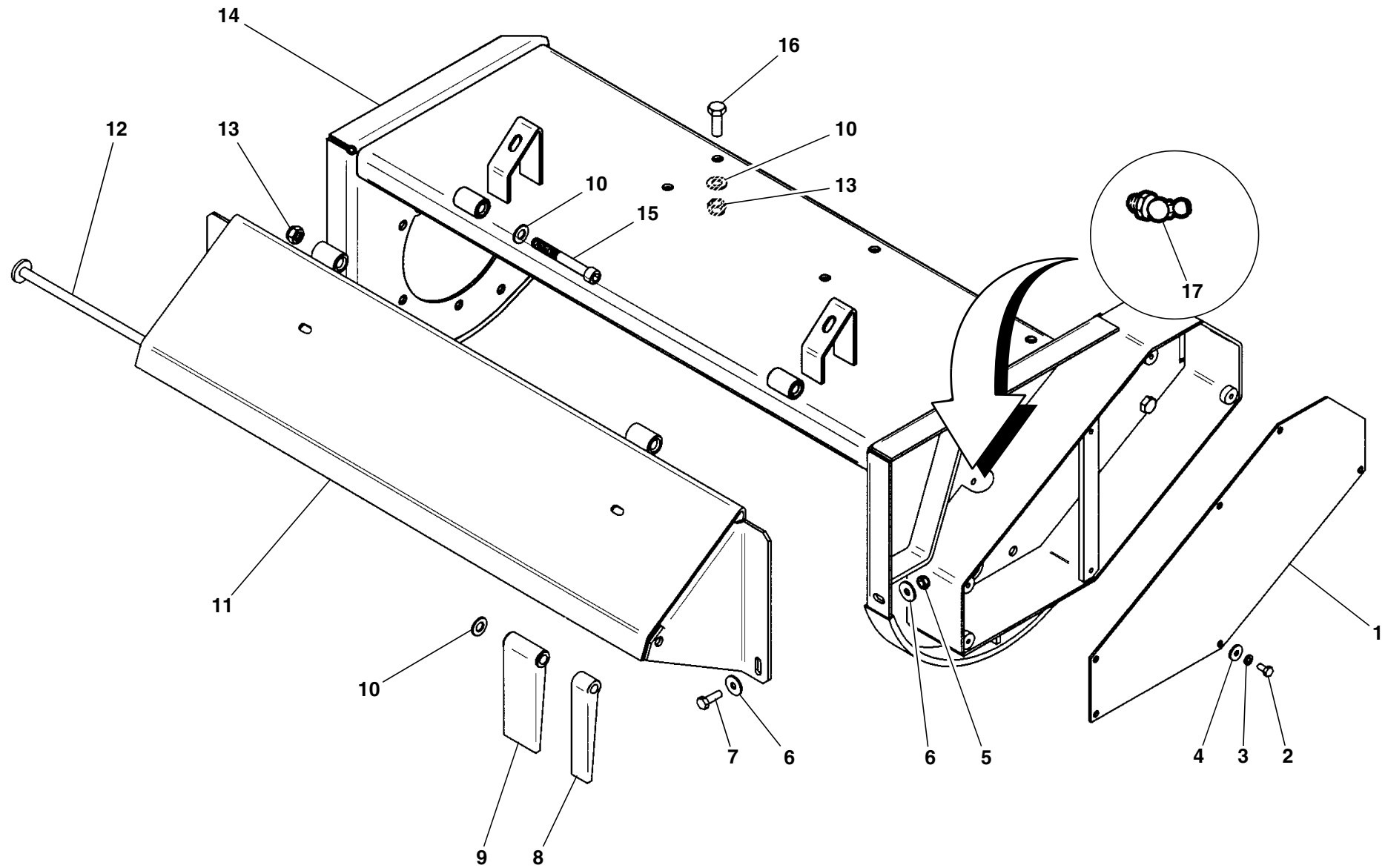

UT 80/125 - UT100 F - UT125 F

TAV. 1386

RIF.	CODICE	DESCRIZIONE	N.
1	3005531		1
2	1190804	M8x16 UNI7380	6
3	1508150	ø8 UNI6798A	6
4	1309243	9x24x3	6
5	1012410	M10 UNI7474	2
6	1310303	ø10 UNI6593	4
7	1111010	M10x30 UNI5739	2
8	3008686	UT 80	3
	3008686	UT100 - UT100 F	1
	3008686	UT125 - UT125 F	2
9	3008685	UT 80	9
	3008685	UT100 - UT100 F	13
	3008685	UT125 - UT125 F	16
10	1114000	ø14 UNI6592	—
11	3005539	UT 80	1
	3008564	UT100 - UT100 F	1
	3008565	UT125 - UT125 F	1
12	3005709	UT 80	1
	3005710	UT100 - UT100 F	1
	3005711	UT125 - UT125 F	1
13	1012414	M14 UNI7474	6
14	3010100	UT 80	1
	3010101	UT100 - UT100 F	1
	3010102	UT125 - UT125 F	1
15	1121442	M14x110 UNI5931	2
16	1111414	M14x40 UNI5739	4
17	0002653	M10x1x45°	1

RIF.	CODICE	DESCRIZIONE	N.

RIF.	CODICE	DESCRIZIONE	N.

TAV. 1386/2

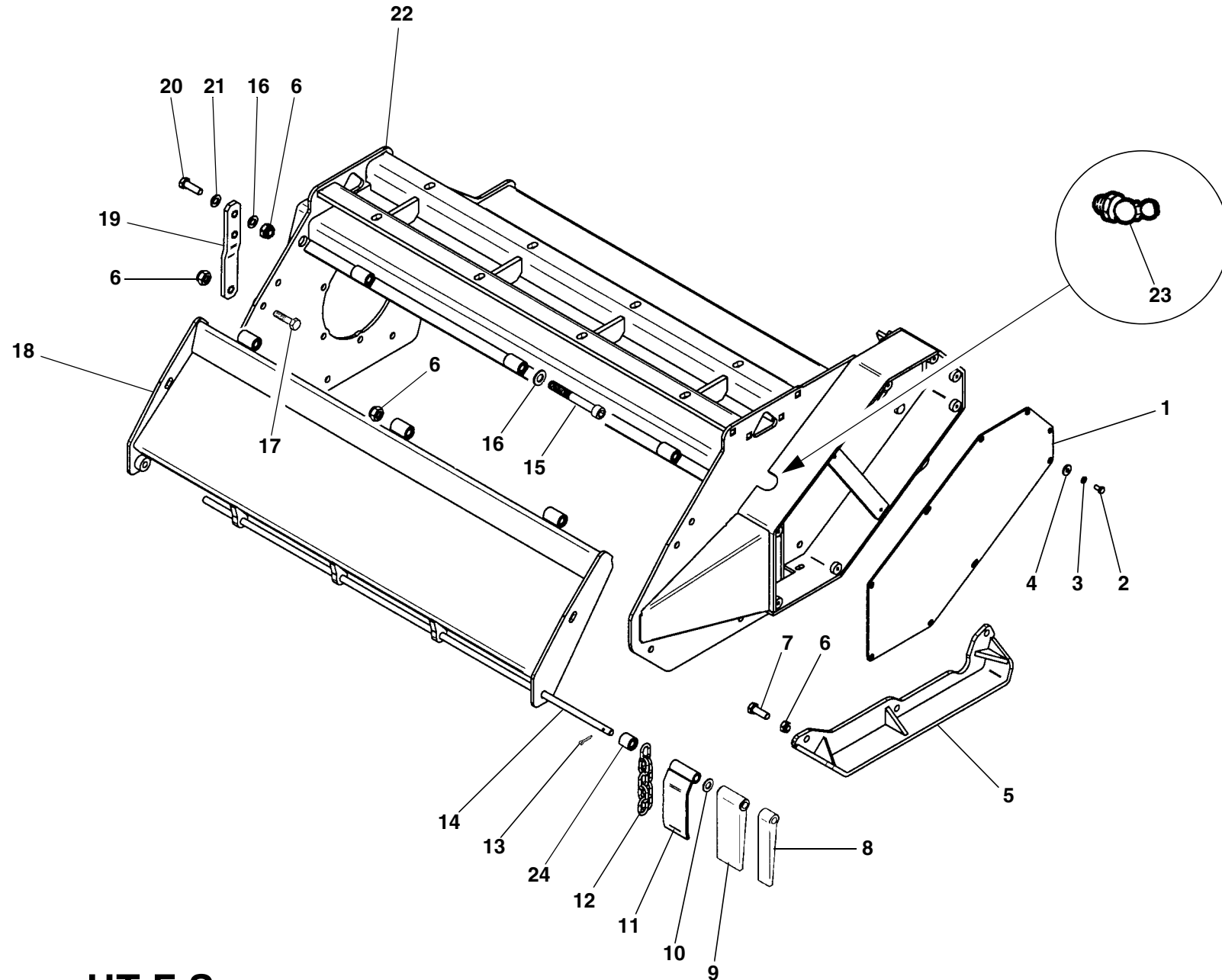

UT Super - UT F Super

TAV. 1386/2

RIF.	CODICE	DESCRIZIONE	N.
1	3011712		1
2	1190804	M8x16 UNI7380	9
3	1508150	ø8 UNI6798A	9
4	1309243	ø8 UNI6593	9
5	3011718	Sx	1
	3011719	Dx	1
6	1012414	M14 UNI7474	6
7	1111414	M14x40 UNI5739	6
8	3008686		—
9	3008685	UT 100 Super - UT 100 F Super	13
	3008685	UT 125 Super - UT 125 F Super	16
	3008685	UT 150 Super - UT 1150 F Super	19
10	1114000	ø14 6592	—
11	3000197	UT 100 Super - UT 100 F Super	13
	3000197	UT 125 Super - UT 125 F Super	16
	3000197	UT 150 Super - UT 1150 F Super	19
12	3007650	UT 100 Super - UT 100 F Super	32
	3007650	UT 125 Super - UT 125 F Super	40
	3007650	UT 150 Super - UT 1150 F Super	48
13	1559028	ø4,5x45 UNI1336	1
14	3011878	UT 100 Super - UT 100 F Super	1
	3011725	UT 125 Super - UT 125 F Super	1
	3011879	UT 150 Super - UT 1150 F Super	1
15	1121442	M14x110 UNI5931	3
16	1114000	ø14 UNI6592	9
17	1101420	M14x55 UNI5737	6
18	3011811	UT 100 Super - UT 100 F Super	1

RIF.	CODICE	DESCRIZIONE	N.
	3011714	UT 125 Super - UT 125 F Super	1
	3011816	UT 150 Super - UT 1150 F Super	1
19	3002406		2
20	1111416	M14x45 UNI5739	2
21	3001118	ø14,5x35x5	6
22	3011809	UT 100 Super - UT 100 F Super	1
	3011706	UT 125 Super - UT 125 F Super	1
	3011814	UT 150 Super - UT 1150 F Super	1
23	0002653	M10x1x45°	1
24	3001545	UT 100 Super - UT 100 F Super	29
	3001545	UT 125 Super - UT 125 F Super	36
	3001545	UT 150 Super - UT 1150 F Super	43

RIF.	CODICE	DESCRIZIONE	N.

TAV. 1386/3

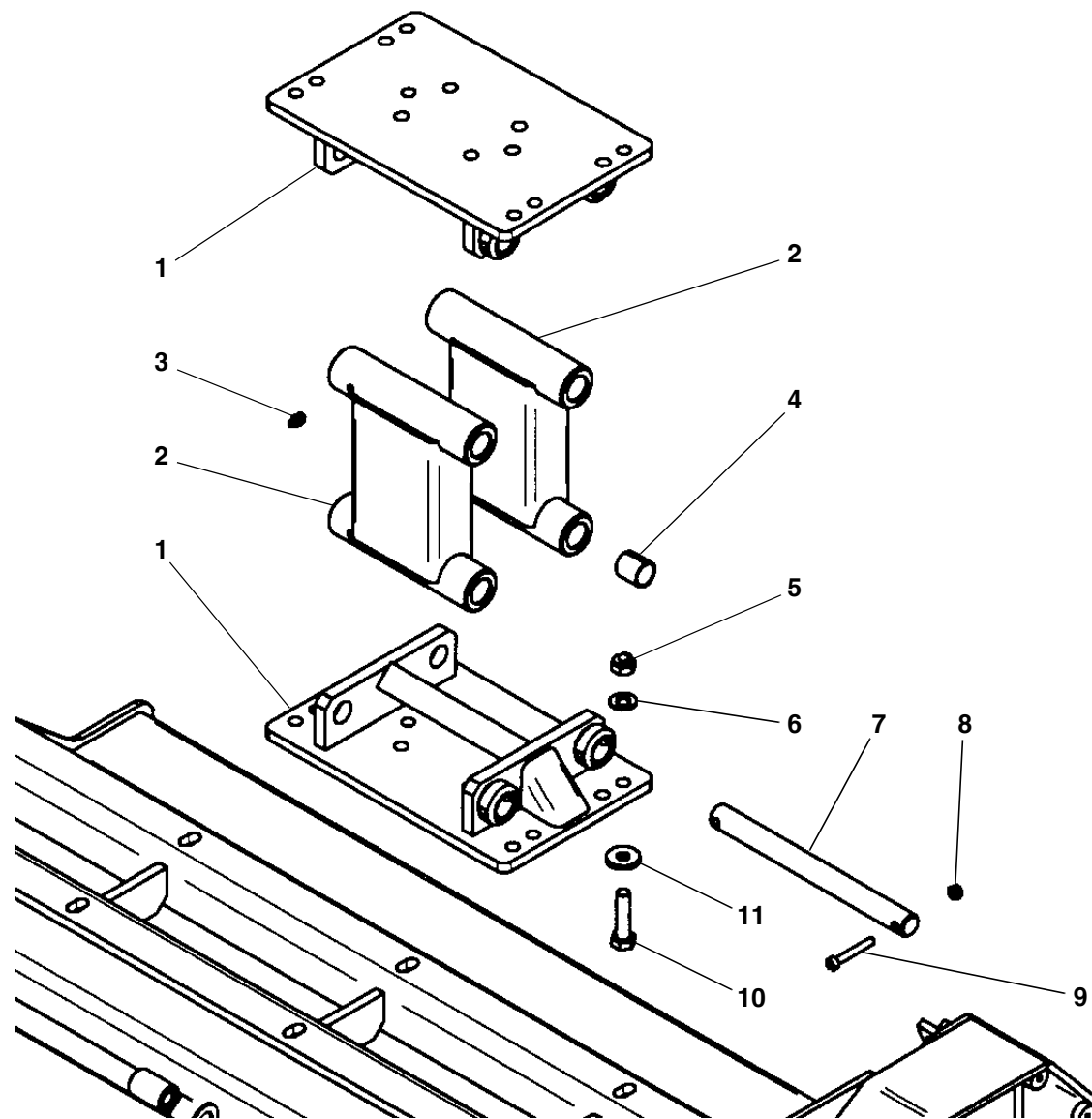

TAV. 1386/3

RIF.	CODICE	DESCRIZIONE	N.
1	3010169		2
2	3010171		2
3	0002654	M10x1	4
4	0001490	KU 25x28x30	8
5	1012414	M14 UNI7474	4
6	1114000	ø14 UNI6592	4
7	3010172		4
8	1012408	M8 UNI7474	4
9	1120820	M8x55 UNI5931	4
10	1101420	M14x55 UNI5737	4
11	3001118	ø14,5x35x5	4

RIF.	CODICE	DESCRIZIONE	N.
------	--------	-------------	----

RIF.	CODICE	DESCRIZIONE	N.
------	--------	-------------	----

TAV. 1387

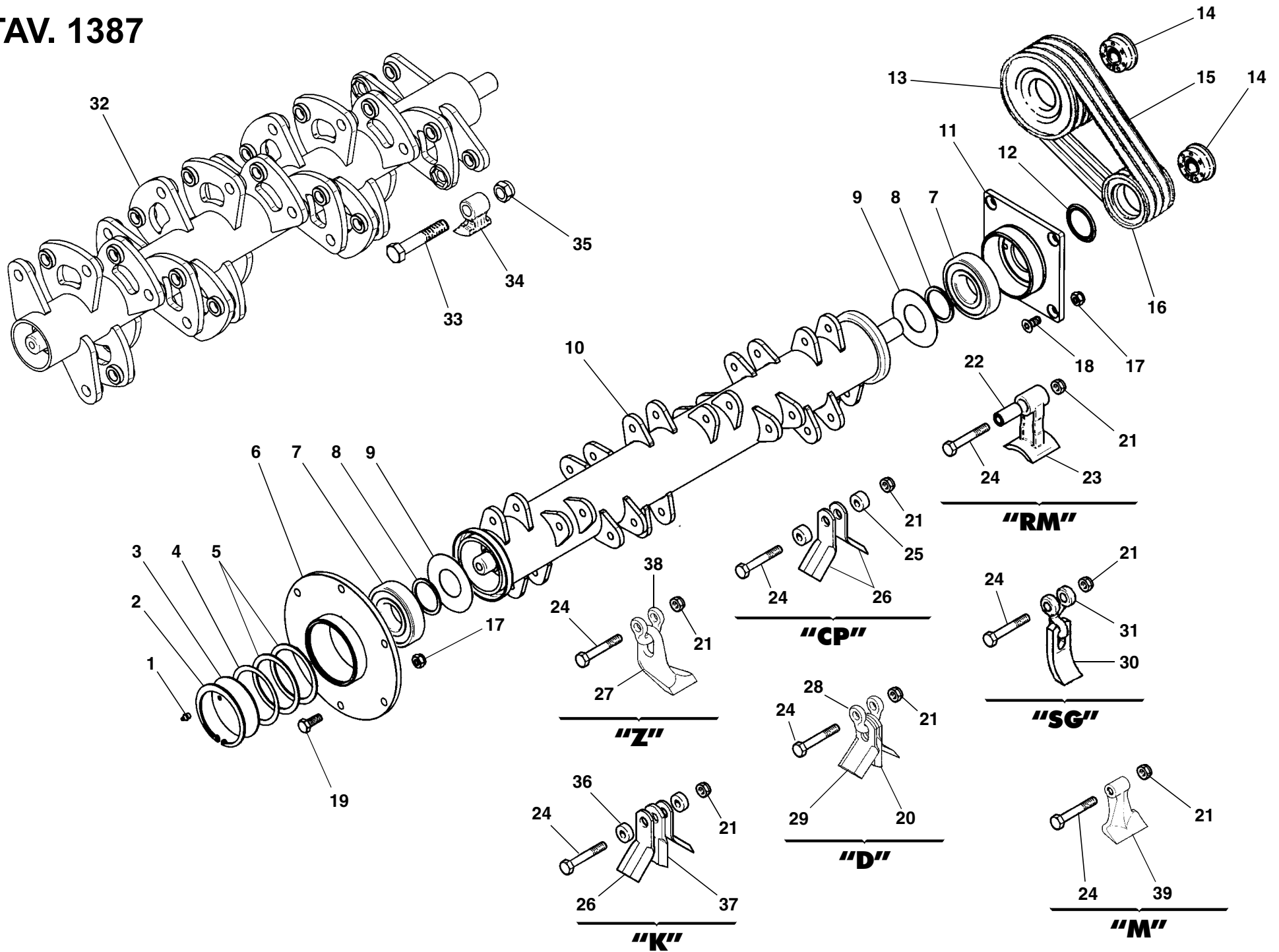

TAV. 1387

RIF.	CODICE	DESCRIZIONE	N.
1	0002654	M10x1	1
2	1020120	Seeger I 120 UNI7437	1
3	3003067		1
4	3004403		1
5	3001936		2
6	3010109		1
7	0001405	6311-2RS	2
8	3000640		2
9	3000346		2
10	3010116	UT80 "Z"-"CP"-"D"-"K"	1
	3010118	UT100 - UT100 Super "Z"-"CP"-"D"-"K"-"RM"	1
	3010148	UT100 "SG"	1
	3010120	UT125 - UT125 Super "Z"-"CP"-"D"-"K"-"RM"	1
	3010149	UT125 "SG"	1
	3010147	UT 150 - UT150 Super "CP"-"K"-"RM"	1
11	3010108		1
12	0001821	A-NBR 55x75x5,5	1
13	3005564	140x3 SPA UT80	1
	3011693	180x3 SPA UT100 Super	1
	3008510	150x4 SPA UT100 F - UT125 F UT100 F Super - UT125 F Super	1
	3008532	160x4 SPA UT150 - UT150 Super "CP" - "K"	1
	3008510	150x4 SPA UT 150 Super "RM" UT 150 F Super	1

RIF.	CODICE	DESCRIZIONE	N.
14	0001342	35x65	2
15	0001026	SPA-X 1060 UT80-UT100-UT125	3
	0001026	SPA-X 1060 UT100 F - UT125 F - UT150	4
	0001018	SPA-X 1180 UT100 Super	3
	0001004	SPA-X 1157 UT F Super	4
16	3008356	120x3 SPA UT100 Super	1
	3007941	112x4 SPA UT100 F - UT125 F UT 150 - UT150 Super "CP" - "K"	1
	3008531	120x4 SPA UT 150 - UT 150 Super "RM"	1
17	1012414	M14 UNI7474	14
18	1181410	M14x30 UNI5933 UT 80/125 UT 100 F - 125 F	4
	1181414	M14x40 UNI5933 UT100/125 Super UT100/125 F Super	4
19	1111412	M14x30 UNI5739 UT 80/125 UT 100 F - 125 F	6
	1111414	M14x40 UNI5739 UT100/125 Super UT100/125 F Super	6
20	3005675	UT 80	12
	3005675	UT 100	16
	3005675	UT 125	20
21	1012414	M14 UNI7474 UT80	12
	1012414	M14 UNI7474 UT100-UT100 Super "Z"-"CP"-"D"-"K"-"RM"	16
	1012414	M14 UNI7474 UT100 - UT 100 Super "SG"	24
	1012414	M14 UNI7474 UT125-UT125 Super "Z"-"CP"-"D"-"K"-"RM"	20

RIF.	CODICE	DESCRIZIONE	N.
	1012414	M14 UNI7474 UT125 - UT125 Super "SG"	30
	1012414	M14 UNI7474 (UT150-150 Super "CP"-"RM"-"K")	24
22	3008322	UT100 - UT100 Super	16
	3008322	UT125 - UT125 Super	20
	3008322	UT150 - UT150 Super	24
23	3008321	UT100 - UT100 Super	16
	3008321	UT125 - UT125 Super	20
	3008321	UT150 - UT150 Super	24
24	3006825	M14x90 UT80	12
	3006825	M14x90 UT100 - UT100 Super "Z"-"CP"-"D"-"K"-"RM"	16
	3006825	M14x90 UT100 - UT100 Super "SG"	24
	3006825	M14x90 UT125 - UT125 Super "Z"-"CP"-"D"-"K"-"RM"	20
	3006825	M14x90 UT125 - UT125 Super "SG"	30
25	3006281	UT80	24
	3006281	UT100 - UT100 Super	32
	3006281	UT125 - UT125 Super	40
	3006281	UT150 - UT150 Super	48
26	3006280	UT 80	24
	3006280	UT100 - UT100 Super	32
	3006280	UT125 - UT125 Super	40
	3006280	UT150 - UT150 Super	48
27	3005723	UT80	12
	3005723	UT100 - UT100 Super	16
	3005723	UT125 - UT125 Super	20

TAV. 1387

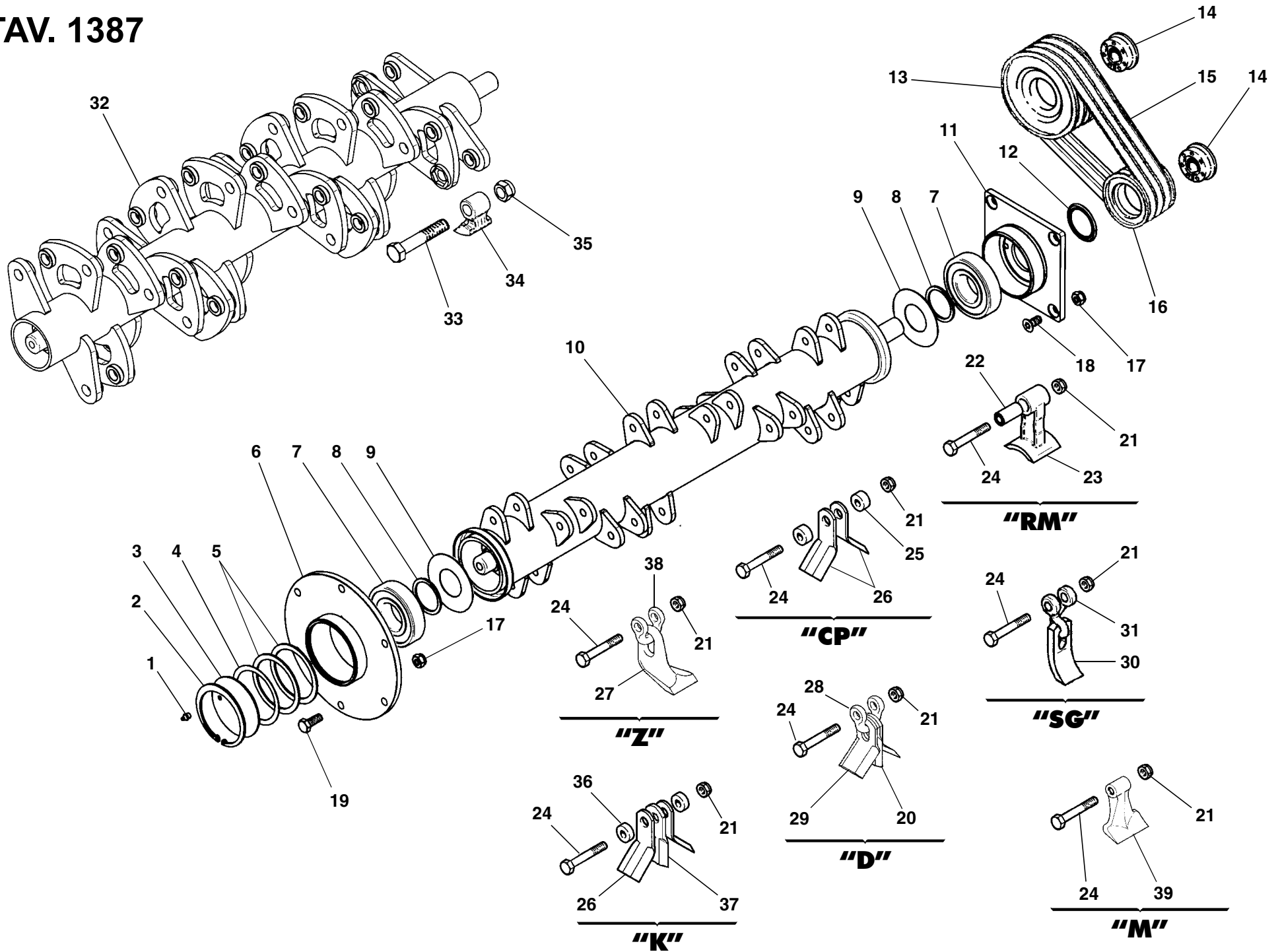

TAV. 1387

RIF.	CODICE	DESCRIZIONE	N.
28	3005676	UT80	12
	3005676	UT100 - UT100 Super	16
	3005676	UT125 - UT125 Super	20
29	3005674	UT80	24
	3005674	UT100 - UT100 Super	32
	3005674	UT125 - UT125 Super	40
30	3007087	UT100 - UT100 Super	24
	3007087	UT125 - UT125 Super	30
31	3007088	UT100 - UT100 Super	24
	3007088	UT125 - UT125 Super	30
32	3010127	UT100 F - UT100 F Super	1
	3010125	UT125 F - UT125 F Super	1
	3012090	UT150 F Super	1
33	3008958	UT100 F - UT100 F Super	18
	3008958	UT125 F - UT125 F Super	24
	3008958	UT 150 F Super	30
34	3008045	UT100 F - UT100 F Super	18
	3008045	UT125 F - UT125 F Super	24
	3008045	UT 150 F Super	30
35	1012424	UT100 F - UT100 F Super	18
	1012424	UT125 F - UT125 F Super	24
	1012414	UT 150 F Super	30
36	3008350	UT80	24
	3008350	UT100 - UT100 Super	32
	3008350	UT125 - UT125 Super	40
	3008350	UT150 - UT150 Super	48

RIF.	CODICE	DESCRIZIONE	N.
37	3008349	UT80	12
	3008349	UT100 - UT100 Super	16
	3008349	UT125 - UT125 Super	20
	3008349	UT150 - UT150 Super	24
38	3012080	UT 80	12
	3012080	UT100 - UT100 Super	16
	3012080	UT125 - UT125 Super	20
39	3002322	UT 80	12
	3002322	UT100 - UT100 Super	16
	3002322	UT125 - UT125 Super	20

RIF.	CODICE	DESCRIZIONE	N.

TAV. 1388

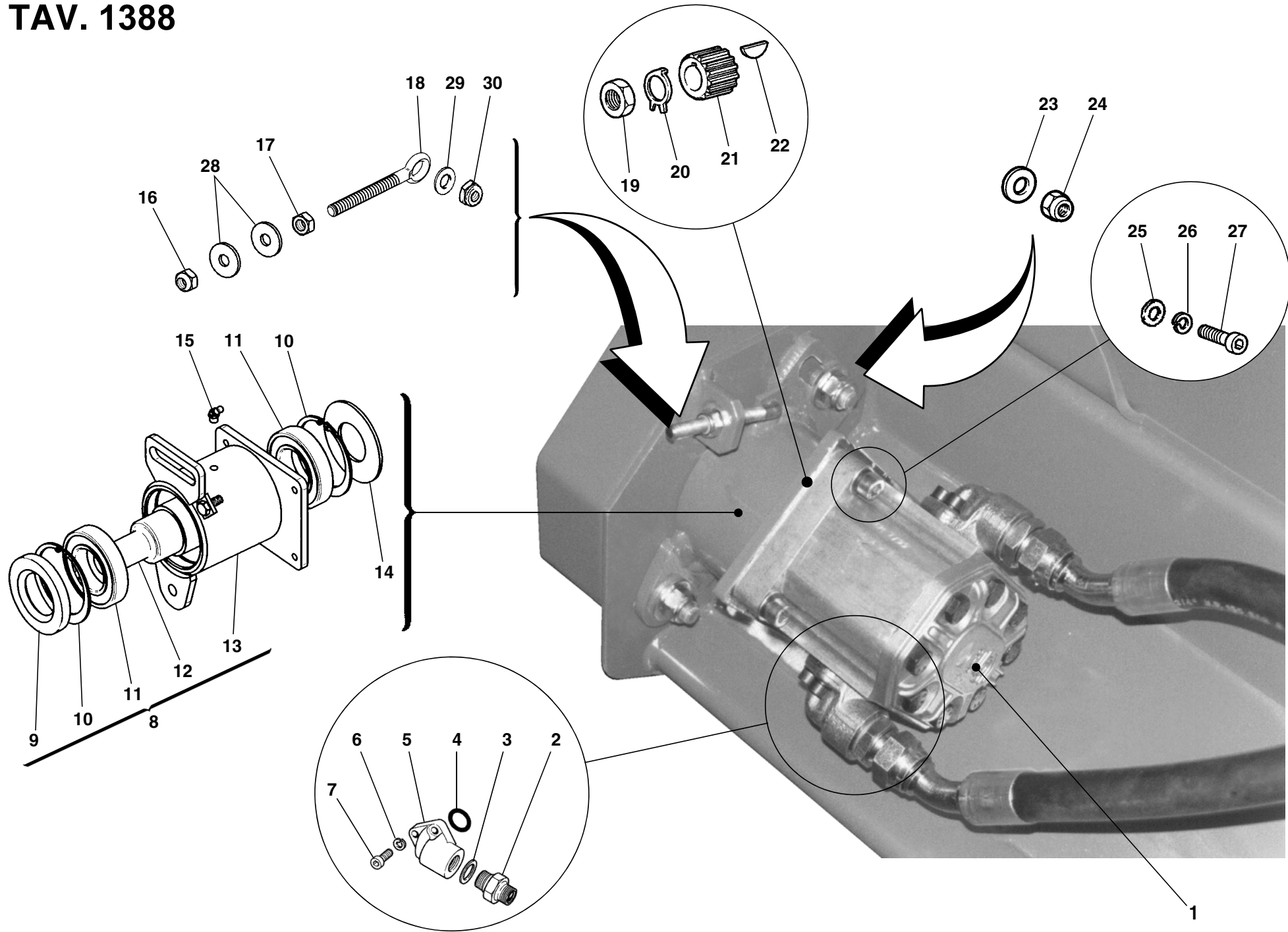

TAV. 1' , ,

RIF.	CODICE	DESCRIZIONE	N.
1	0003541		1
2	0002306	3/4"-3/4"	2
3	0002026	3/4"	2
4	0001701	OR 132	2
5	0002309	3/4"x40	2
6	1208000	ø8 UNI1751	6
7	1120808	M8x25 UNI5931	6
8	3012778		1
9	0001831	55x100x13	1
10	1020100	Seeger I 100 UNI7437	2
11	0001488	6211-2RS	2
12	3007773		1
13	3012676		1
14	3004762		1
15	0002653	M10x1x45°	1
16	1012410	M10 UNI7474	1
17	1012510	M10 UNI5588	1
18	0007447		1
19	1021514	M14x1,5 UNI5589	1
20	0002986		1
21	0002917		1
22	1551007	4x7,5x18,57 UNI6606	1
23	3001118	14,5x35x5	2
24	1012414	M14 UNI7474	2
25	1110000	ø10 UNI6592	4
26	1210000	ø10 UNI1751	4

RIF.	CODICE	DESCRIZIONE	N.
27	1121014	M10x40 UNI5931	4
28	1310303	ø10x30x3 UNI6593	2
29	1112000	ø12 UNI6592	1
30	1012412	M12 UNI7474	1

RIF.	CODICE	DESCRIZIONE	N.

TAV. 1389

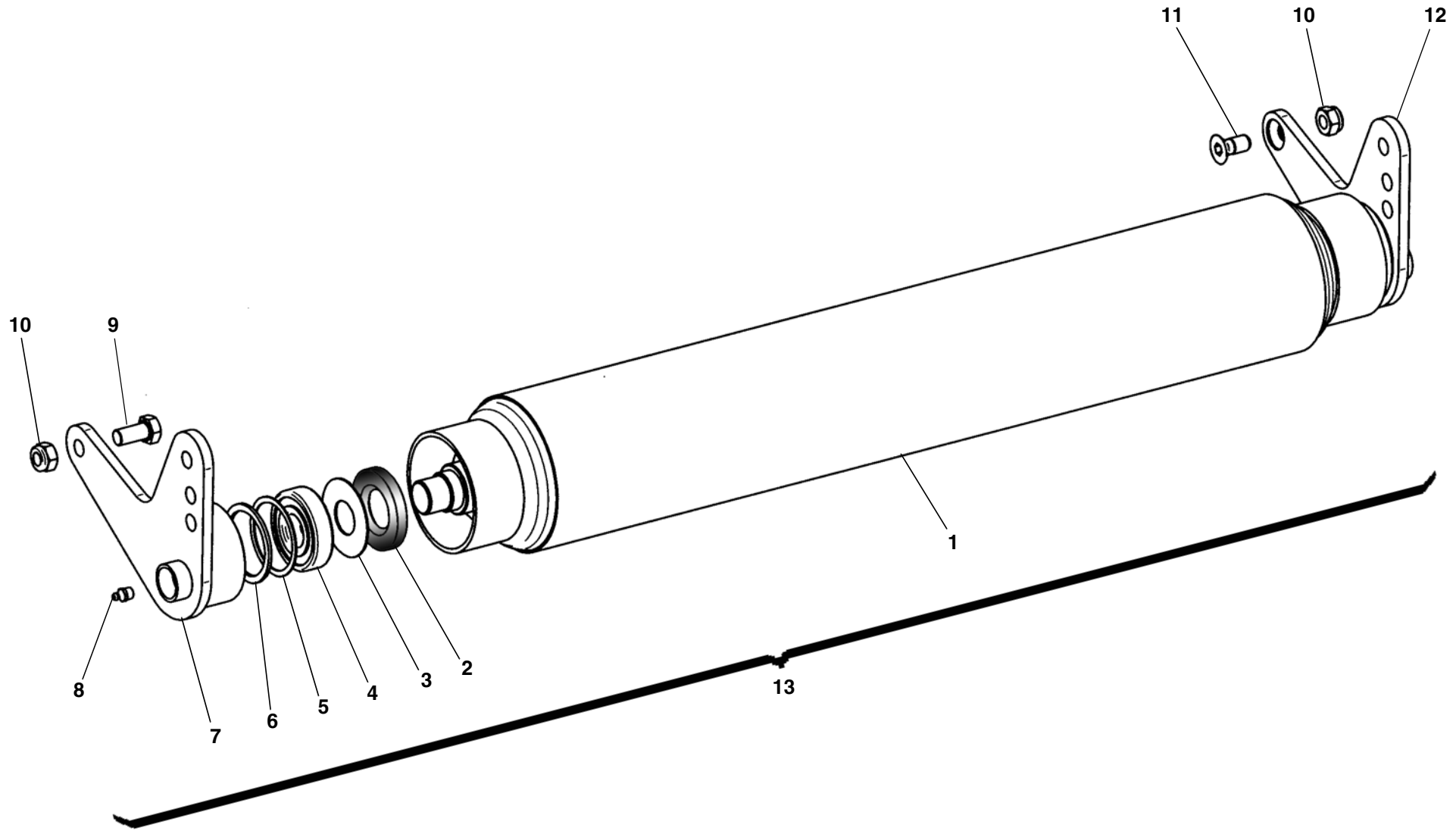

TAV. 1389

RIF.	CODICE	DESCRIZIONE	N.
1	3005546	UT 80	1
	3005547	UT100 - UT100 F	1
	3005548	UT125 - UT125 F	1
	3008516	UT 150	1
2	0001805	35x72x10	2
3	3000648		2
4	0001521	21306	2
5	3000181	61x71,5x1,2	2
6	3000640	65x71x3	2
7	3005629	Sx	1
8	0002654	M10x1	2
9	1111410	M14x30 UNI5739	3
10	1012414	M14 UNI7474	4
11	1181410	M14x30 UNI5933	1
12	3013888	Dx	1
13	8815005	UT 80	1
	8815006	UT100 - UT100 F	1
	8815007	UT125 - UT125 F	1
	8815083	UT150	1

RIF.	CODICE	DESCRIZIONE	N.
------	--------	-------------	----

RIF.	CODICE	DESCRIZIONE	N.
------	--------	-------------	----

TAV. 1389/1

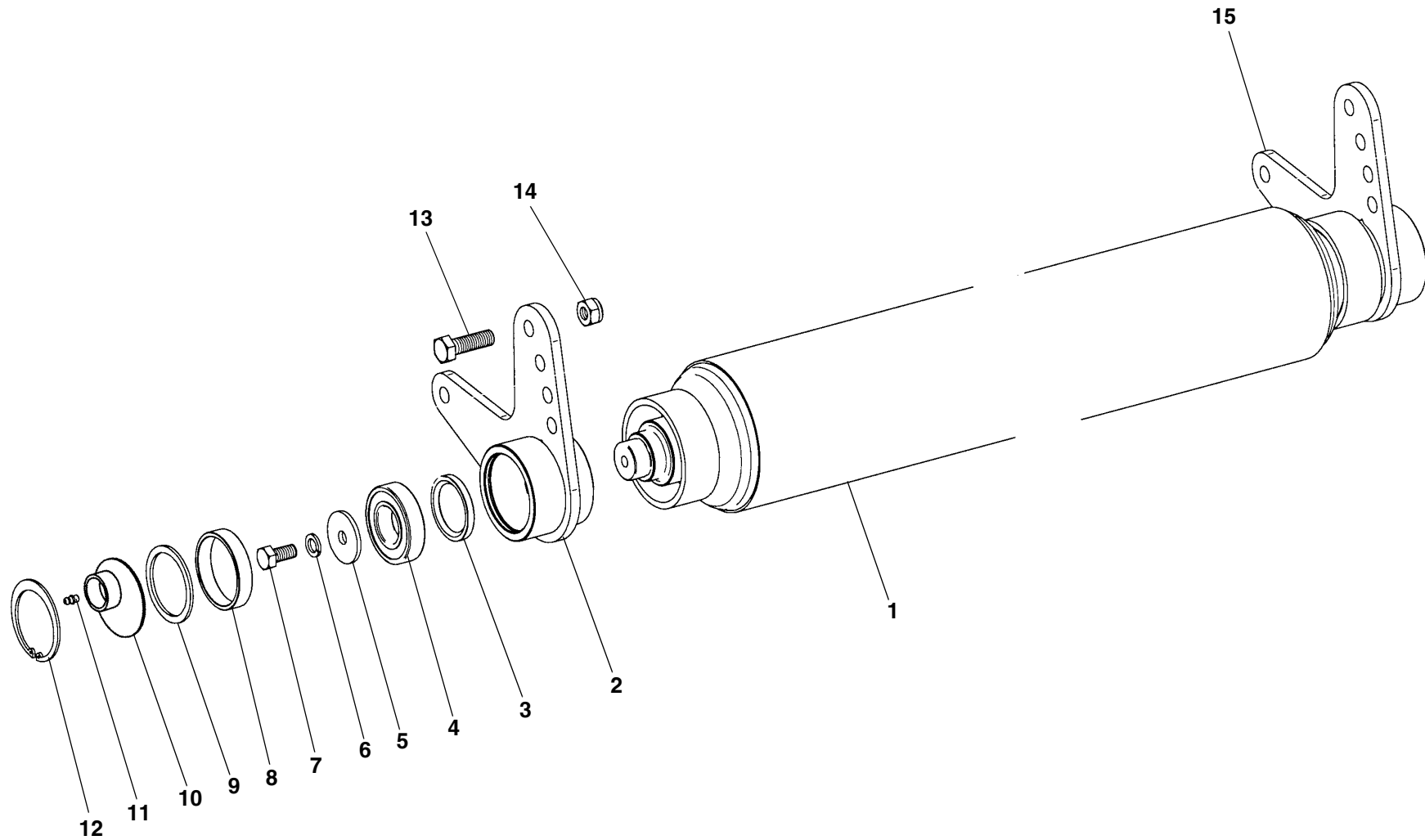

UT100/150 Super - UT 100/150 F Super

TAV. 1389/1

RIF.	CODICE	DESCRIZIONE	N.
1	3011820	UT100 Super - UT100 F Super	1
	3011122	UT125 Super - UT125 F Super	1
	3011053	UT150 Super - UT150 F Super	1
2	3010655	Sx	1
3	0001803	45x60x7	2
4	0001452	6207	2
5	3008431		2
6	1212000	ø12 UNI1751	2
7	1111208	M12x25 UNI5739	2
8	3008429		2
9	3000640		2
10	3012038		2
11	0002659	M6	2
12	1020072	Seeger I 72 UNI7437	2
13	1111416	M14x45 UNI5739	4
14	1012414	M14 UNI7474	4
15	3010656	Dx	1

RIF.	CODICE	DESCRIZIONE	N.
------	--------	-------------	----

RIF.	CODICE	DESCRIZIONE	N.
------	--------	-------------	----

