



XB 150 S - N° 11882

Ölmenge 42 l/min

CATALOGO PARTI DI RICAMBIO
SPARE PARTS CATALOGUE
CATALOGUE PIECES DE RECHANGE
ERSATZTEILLISTE
CATÁLOGO PARTES DE REQUESTO

110 • 130 • 150 • 180

per ordinare i pezzi di ricambio

Per una corretta ordinazione dei pezzi di ricambio delle nostre macchine è necessario indicare i seguenti elementi:

- 1) Modello della macchina.
 - 2) Numero di codice e Numero di catalogo.
 - 3) Descrizione.
 - 4) Quantità richiesta.
-

pour commander les pièces de rechange

Pour commander les pièces de rechange des notre machine, il faut indiquer:

- 1) Modèle de la machine.
 - 2) Code et Nombre du catalogue.
 - 3) Dénomination.
 - 4) Quantité demandé.
-

to order the spare parts

To order the spare parts of our machines, correctly you must specify:

- 1) Model of the machine.
 - 2) Code number and Catalogue number.
 - 3) Description.
 - 4) Required quantity.
-

um die ersatzteile zu bestellen

Für eine Korrekte Bestellung der Ersatzteile müssen folgende Einzelheiten angegeben werden:

- 1) Gerät-Modell.
- 2) Teil-Nummer und Katalog-Nummer.
- 3) Teil-Bezeichnung.
- 4) Gewünschte Menge.

TAV. 1061

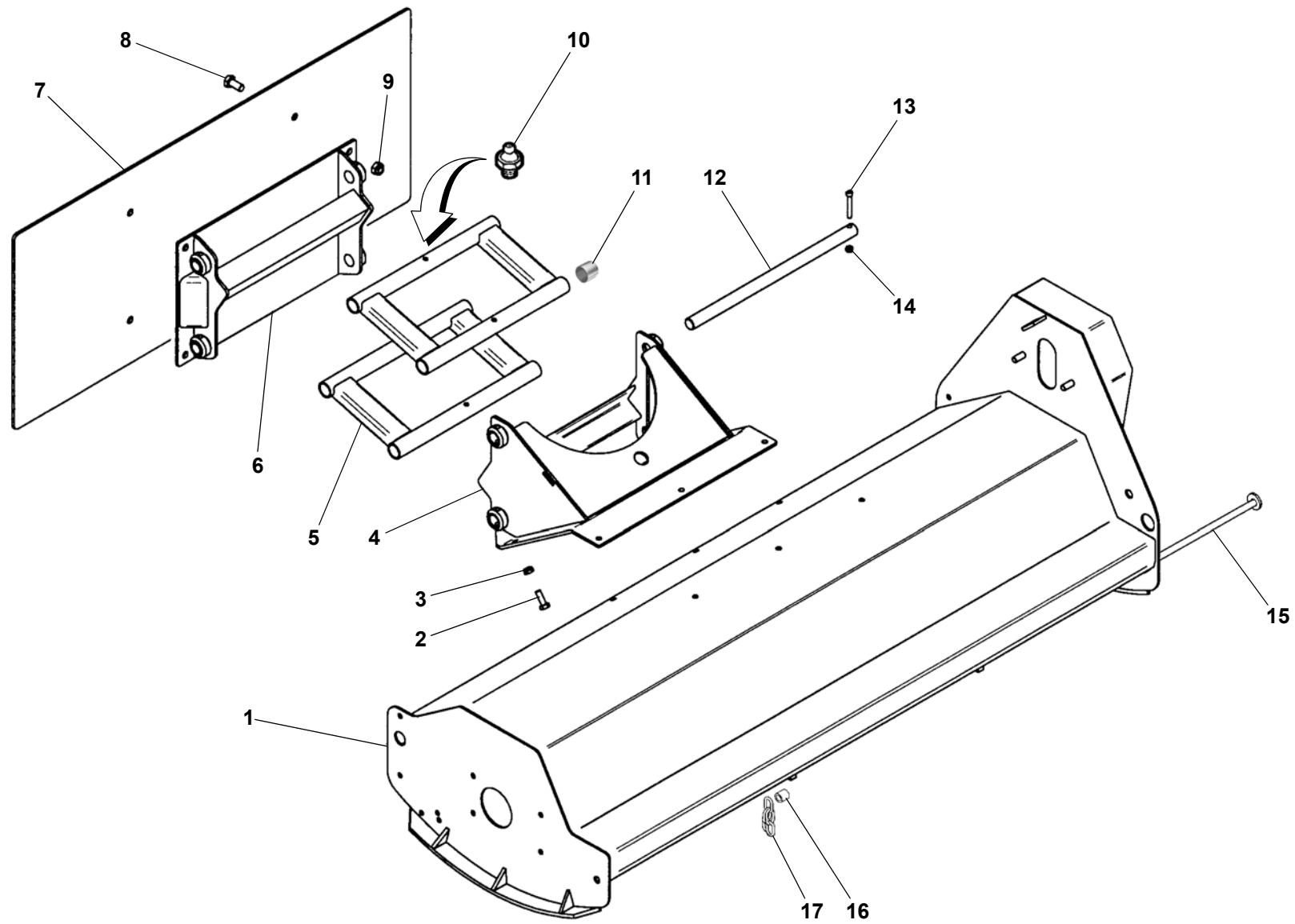

TAV. 1061

RIF.	CODICE	DESCRIZIONE	N.
1	3012918	XB 110	1
	3012917	XB 130	1
	3013008	XB 150 SUPER	1
	3012660	XB 180	1
2	1111010	M10x30 UNI5739	6
3	1012410	M10 UNI7474	6
4	3011843		1
5	3011839		2
6	3011846		1
7	3011881		1
8	1111410	M14x30 UNI5739	4
9	1012414	M14 UNI7474	4
10	0002654	M10x1	4
11	0001490	KU 25x28x30	8
12	3011847		4
13	1120820	M8x55 UNI5931	4
14	1012408	M8 UNI7474	4
15	3008992	XB 110	1
	3007365	XB 130	1
	3007366	XB 150	1
	3007821	XB 180	1
16	3001545	XB 110	35
	3001545	XB 130	41
	3001545	XB 150	48
	3001545	XB 180	54
17	3001883	XB 110	36

RIF.	CODICE	DESCRIZIONE	N.
	3001883	XB 130	43
	3001883	XB 150	49
	3001883	XB 180	58

RIF.	CODICE	DESCRIZIONE	N.
------	--------	-------------	----

TAV. 1062

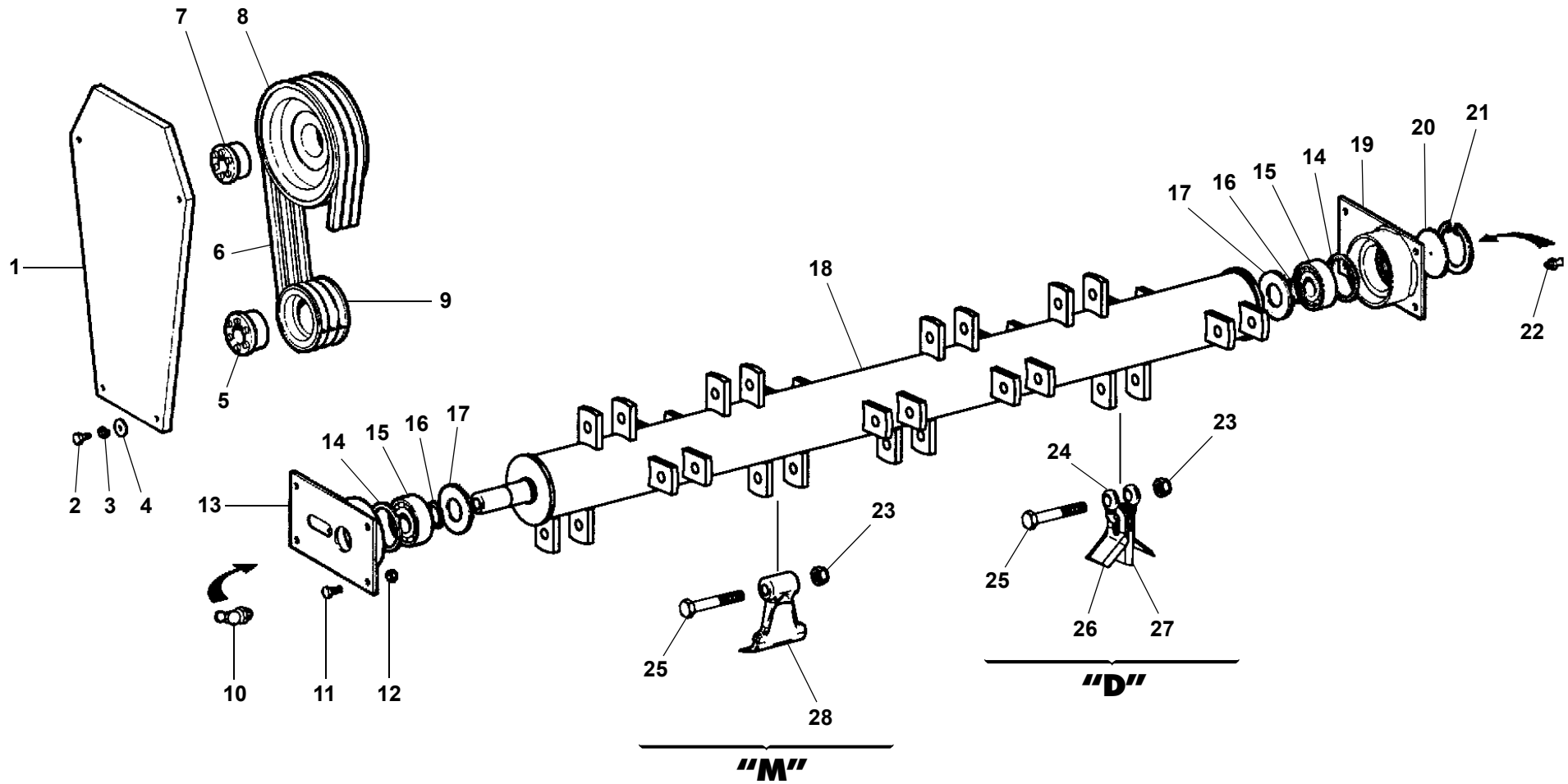

TAV. 1062

RIF.	CODICE	DESCRIZIONE	N.
1	3007286		1
2	1110804	M8x16 UNI5739	6
3	1309243	ø8x24x3 UNI6593	6
4	1508150	ø8 UNI6798A	6
5	0001353	30x65	1
	0001353	30x65 XB 180 "M"	1
6	0001036	SPA-X 1032 XB 110 "M"- "D"	2
	0001036	SPA-X 1032 XB 150 Super	3
7	0001352	25x65	1
8	3001001	SPA 180x2 XB 110 "M"- "D"	1
	3005714	SPA 150x3 XB 150 Super	1
9	3000851	SPA 100x2 XB 110 "M"- "D"	1
	3008357	SPA 130x3 XB 150 Super	1
	3000852	SPA 100x3 XB 180-180 Super "D"	1
	3005565	SPA 112x3 XB 180-180 Super "M"	1
10	0002661	M10x1x90°	1
11	1111006	M10x20 UNI5739	8
12	1012410	M10 UNI7474	8
13	3000979	Sx XB 110/150 Super	1
	3012989	Sx XB 180-180 Super	
14	3000640		2
15	0001421	1306	2
16	3008972	30,5x42x1,5	4
	3000649	30,5x42x0,5	—

RIF.	CODICE	DESCRIZIONE	N.
17	3000648		2
18	3009731	XB 110	1
	3007253	XB 130-130 Super	1
	3007327	XB 150-150 Super	1
	3012987	XB 180-180 Super	1
19	3000978	Dx XB 110/150 Super	1
	3012988	Dx XB 180-180 Super	
20	3000990		1
21	1020072	Seeger I 72 UNI7437	1
22	0002659	M6	1
23	1012414	M14 UNI7474 XB 110-130	16
	1012414	M14 UNI7474 XB 150-180	24
24	3005676	XB 110/130 Super	16
	3005676	XB 150/180 Super	24
25	3006825	M14x90 12.9 XB 110/130 Super	16
	3006825	M14x90 12.9 XB 150/180 Super	24
26	3005674	XB 110/130 Super	32
	3005674	XB 150/180 Super	48
27	3005675	XB 110/130 Super	16
	3005675	XB 150/180 Super	24
28	3009799	XB 110/130 Super	16
	3009799	XB 150/180 Super	24

RIF.	CODICE	DESCRIZIONE	N.

TAV. 1063

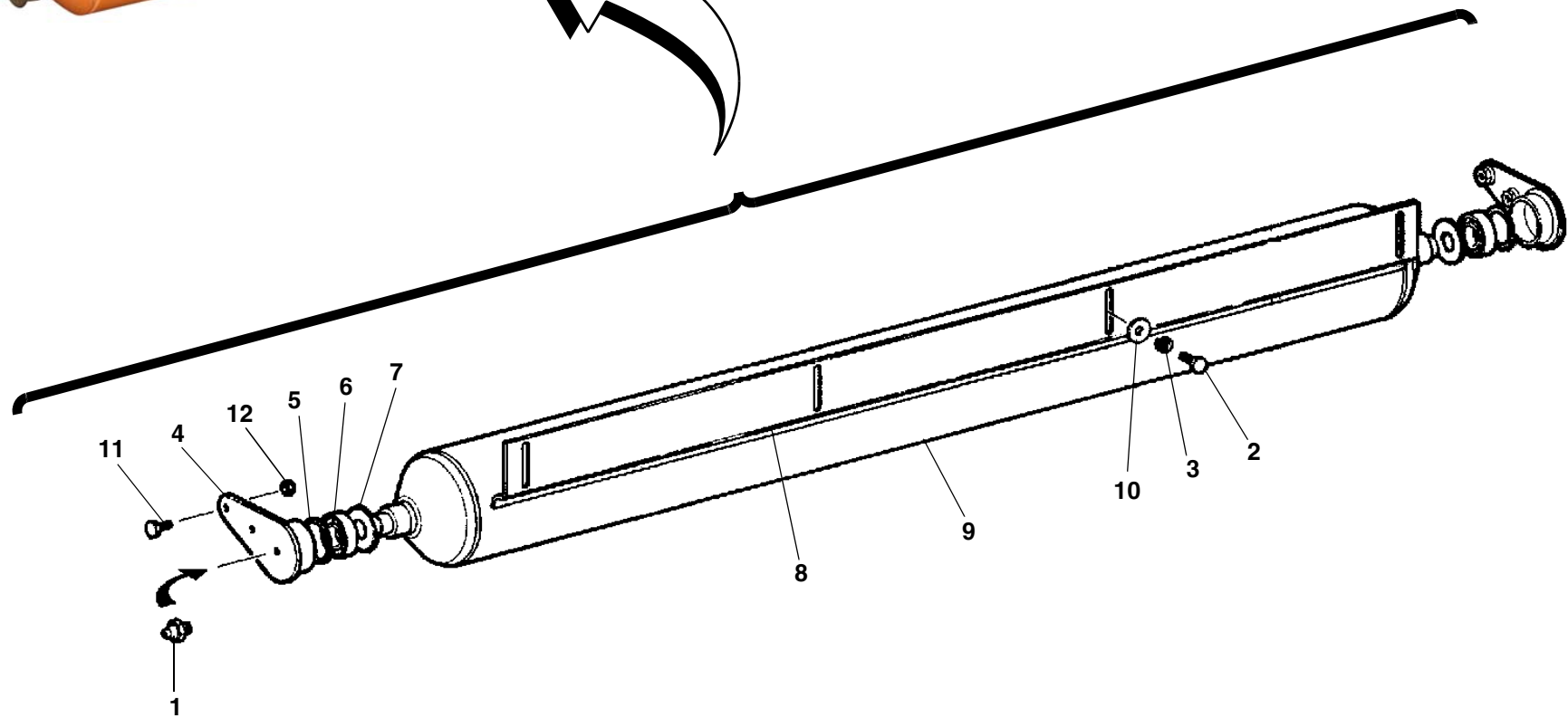

TAV. 1063

RIF.	CODICE	DESCRIZIONE	N.
1	0002654	M10x1	2
2	1111006	M10x20 UNI5739 XB 110/150	4
	1111006	M10x20 UNI5739 XB 180	5
3	1210000	ø10 UNI1751 XB 110/150	4
	1210000	ø10 UNI1751 XB 180	5
4	3002717		2
5	3000180	45x51,5x1,5	2
6	0001411	6205-2RS	2
7	3000486		2
8	3005363	XB 110	1
	3002736	XB 130	1
	3002703	XB 150	1
	3007785	XB 180	1
9	3005365	XB 110	1
	3000429	XB 130 - XB 130 Super	1
	3002715	XB 150 - XB 150 Super	1
	3007784	XB 180 - XB 180 Super	1
10	1310303	ø10 UNI6593 XB 110/150	4
	1310303	ø10 UNI6593 XB 180	5
11	1111010	M10x30 UNI5739	4
12	1012410	M10 UNI7474	4

RIF.	CODICE	DESCRIZIONE	N.
------	--------	-------------	----

RIF.	CODICE	DESCRIZIONE	N.
------	--------	-------------	----

TAV. 1063/1

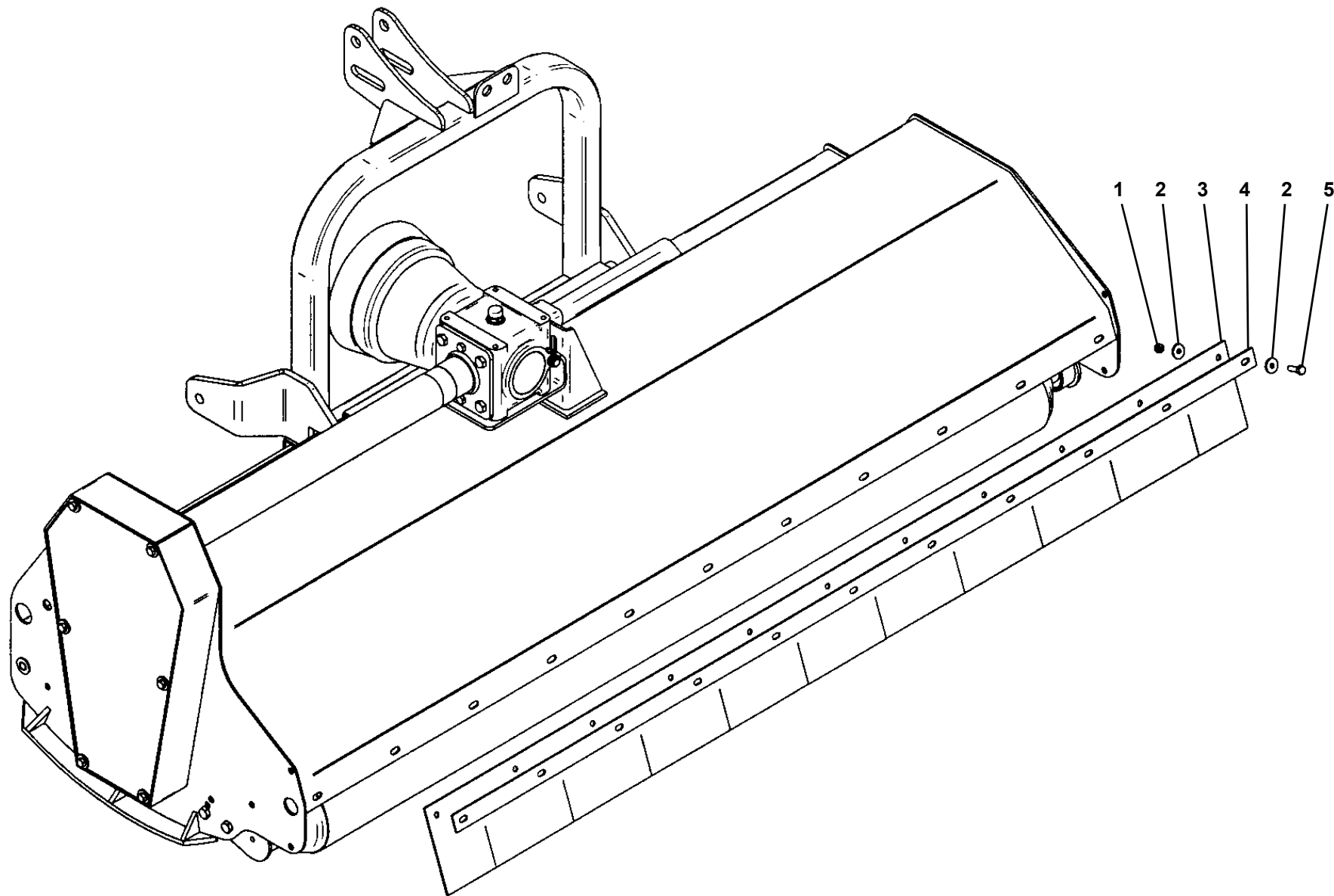

XB Super

TAV. 1063/1

RIF.	CODICE	DESCRIZIONE	N.
1	1012408	M8 UNI7474 XB 130 Super	8
	1012408	M8 UNI7474 XB 150 Super	9
	1012408	M8 UNI7474 XB 180 Super	11
2	1309243	ø8 UNI6593 XB 130 Super	16
	1309243	ø8 UNI6593 XB 150 Super	18
	1309243	ø8 UNI6593 XB 180 Super	22
3	3009502	XB 130 Super	1
	3009503	XB 150 Super	1
	3010009	XB 180 Super	1
4	3009504	XB 130 Super	1
	3009505	XB 150 Super	1
	3010008	XB 180 Super	1
5	1110806	M8x20 UNI5739 XB 130 S	8
	1110806	M8x20 UNI5739 XB 150 S	9
	1110806	M8x20 UNI5739 XB 180 S	11

RIF.	CODICE	DESCRIZIONE	N.
------	--------	-------------	----

RIF.	CODICE	DESCRIZIONE	N.
------	--------	-------------	----

TAV. 1064/HA

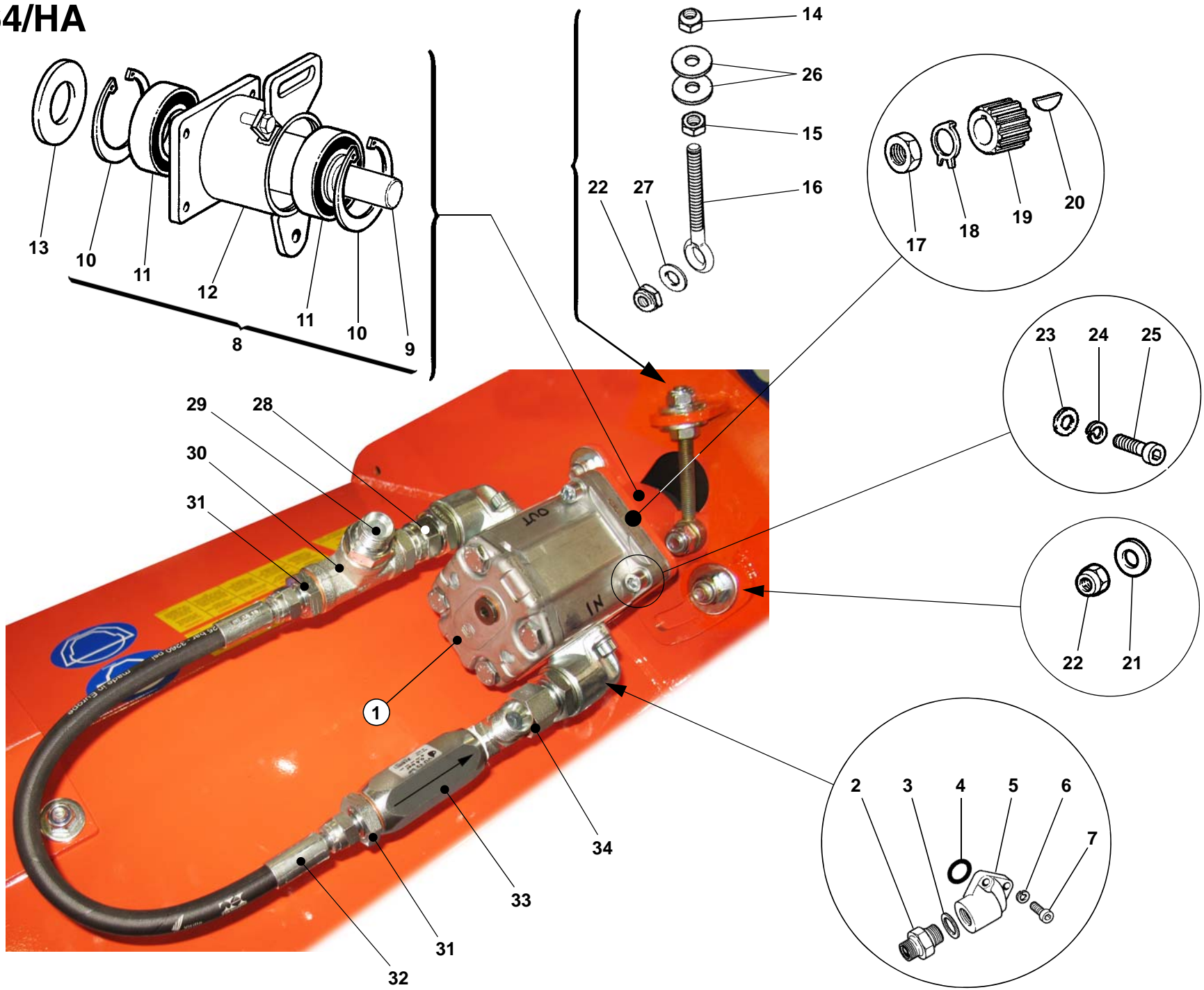

TAV. 1064/HA

RIF.	CODICE	DESCRIZIONE	N.
1	0004170		1
2	0002310	3/4"-1/2"	2
3	0002026	3/4"	2
4	0001701	OR 132	2
5	0002309	3/4"x40	2
6	1208000	ø8 UNI1751	4
7	1120810	M8x30 UNI5931	4
8	3012480		1
9	3005853		1
10	1020068	Seeger I 68 UNI7437	2
11	0001493	6008 2RS	2
12	3012478		1
13	3005921		1
14	1012410	M10 UNI7474	1
15	1012510	M10 UNI5588	1
16	0007447		1
17	1021512	M12x1,5 UNI5589	1
18	0002900		1
19	0003515		4
20	1551006	4x6,5x16 UNI6606	1
21	1312363	ø12 UNI6593	4
22	1012412	M12 UNI7474	3
23	1108000	ø8 UNI6592	4
24	1208000	ø8 UNI1751	4
25	1120810	M8x30 UNI5931	4
26	1310303	ø10 UNI6593	2
27	1112000	ø12 UNI6592	1

RIF.	CODICE	DESCRIZIONE	N.
28	0002420	1/2"	1
29	0002305	1/2"	1
30	0002359	1/2"	1
31	0002300	1/2"-1/4"	2
32	0005776	1/4"	1
33	0008712	1/2"	1
34	0002454	1/2"	1

RIF.	CODICE	DESCRIZIONE	N.

