

# QUADSAW

## LRS 1402



**PARTS**

**UK**

8<sup>th</sup> Edition 2018

 **GREENTEC**

*Cutting Edge Technology*



# GreenTec LRS 1402

## PARTS

### 8<sup>th</sup> Edition – Januar 2018

Please ensure that this manual is handed to the operator before using the machine for the first time. If the machine is resold the Parts list must be given to the new owner!

The information contained in this Parts list is correct at the time of publication. However, in the course of constant development, changes in specification are inevitable. Should you find the information given in this book different to the machine it relates to please contact the “After Sales Department” for advice



Merkurvej 25  
DK 6000 Kolding  
Danmark  
Tel: +45 75553644  
Email: [info@greentec.eu](mailto:info@greentec.eu)  
web: [www.greentec.eu](http://www.greentec.eu)

---

## Contents

<b>Contents</b> .....	<b>4</b>
<b>Introduction</b> .....	<b>5</b>
<b>Useful information</b> .....	<b>6</b>
<b>Ordering parts</b> .....	<b>7</b>
<b>Spare parts</b> .....	<b>8</b>
Main Frame .....	8
Transmission „Blade“ .....	10
Transmission Motor .....	12
Belt Tensioner .....	13
Stickers .....	14

## Introduction

Dear customer!

Your new GreenTec machine is constructed with background in more than 20 years experience with tractor mounted machines to maintenance of green areas. This machine is produced by the latest technology and recognized safety regulations, standards and regulations.

We want to make a product available in such a way, that neither the use of the machine during transportation or maintenance of the machine causes any damage or misunderstandings.

This parts list contains information that are important and useful for maintaining your GreenTec machine's reliability, dependability and value.

You are welcome to visit our website [www.greentec.eu](http://www.greentec.eu) - where the login via the dealer's access gives you the latest updates on instructional and part books on our entire product range. The password for dealer log-in: PUBLISHER

We hope, you will be pleased with your new GreenTec machine.

Best regards,



John Christensen  
Sales Director GreenTec A/S



**GreenTec's** vision is to develop and sell quality machines for the maintenance of green areas, including in agriculture, in industry, at airports and in the local sector. Through innovative product development, we will strive to become a leader in our field.

All machines are developed in a simple and functional design in close cooperation with dealers and end users. It is our goal to cover every need in the market segment with preferably 2 different solutions. In-depth analysis of requirements and serious advice to the customer is offered the best solution, where individual needs can be met through the modularity of the product program.

Our goal is also to offer the best possible after sales service, and a quick and efficient spare parts supply.

---

## Useful information

Before using the machine for the first time, it's the seller's responsibility that the buyer is given this parts list. If the machine is resold, the parts list must be transferred to the new owner.

Please fill out the list below to ensure that the necessary information is at hand when ordering spare parts etc.

Serial No

Delivery date

Dealer

Tel./ E-mail



Merkurvej 25  
DK 6000 Kolding  
Denmark  
Tel: +45 75553644  
Email: [info@greentec.eu](mailto:info@greentec.eu)  
web: [www.greentec.eu](http://www.greentec.eu)  
Opening hours: Mon-Fri 8-16

## Ordering parts

When ordering parts please refer to your parts list to help your dealer with your order.

Part number and quantity  
Description  
Machine model number  
Serial number of the machine  
Delivery instructions (e.g. next day).

Delivery is normally via carrier direct to your dealer. Please check with your dealer for stock availability and arrangement of dispatch. Ensure you or your dealer has sufficient cover for parts requirement outside factory hours.

### Important Note

The information contained in this manual is correct at the time of publication. However, in the course of constant development, changes in specification are inevitable. Should you find the information given in this book different to the machine it relates to, please contact the "After Sales Department" for advise.

#### Key:

(LH)	=	Left hand
(RH)	=	Right hand

## Spare parts

### Main Frame

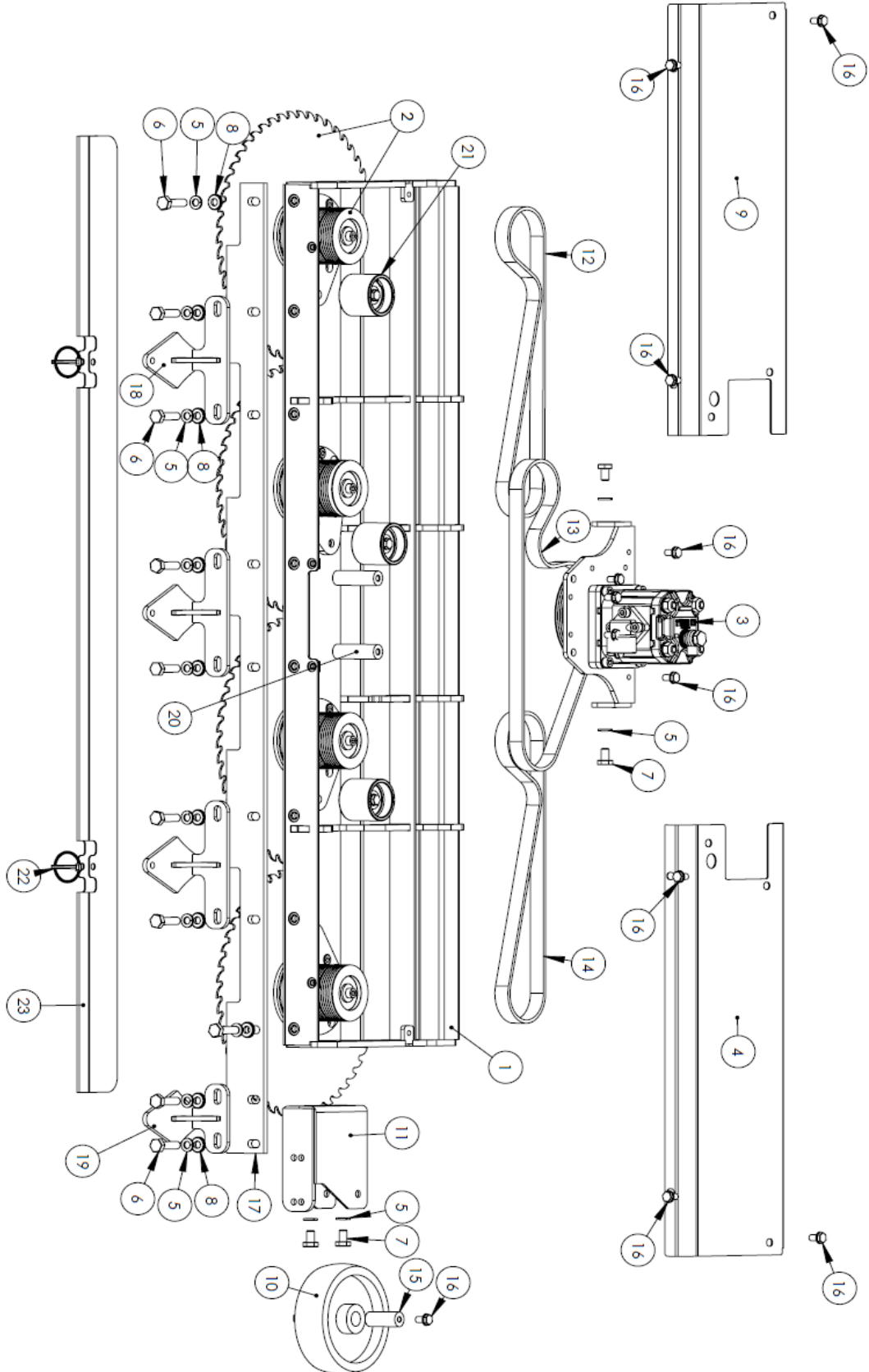



---

**Main Frame**

Item	Qty.	Part no.	Description
1	1	8141501	Body
2	4		See Headline "Transmission Sawblade"
3	1		See Headline "Transmission Motor POST Dec. 2014"
4	1	8141019	Lid (Painted Black)
5	14	2770436	Washer M10
6	10	2770396	Bolt M10x35
7	4	8142002	Bolt M10x16
8	10	8142003	Washer HD M10
9	1	8141020	Lid (Painted Black)
10	1	8146001	Wheel
11	1	8141502	Wheel bracket
12	1	8144001	Belt for blade
13	1	8144002	Belt for motor
14	1	8144001	Belt for blade
15	1	8141003	Shaft
16	16	8142011	Bolt
17	1	8148001	Plastic rail
18	3	8141503	Branch deflector
19	1	8141504	Branch deflector (Lower)
20	2	N/A	Use 8141501
21	3		See Headline "Belt tensioner"
22	2	8146002	Lynch pin
23	2	8141004	Protective guard for blades

**Transmission „Blade“**

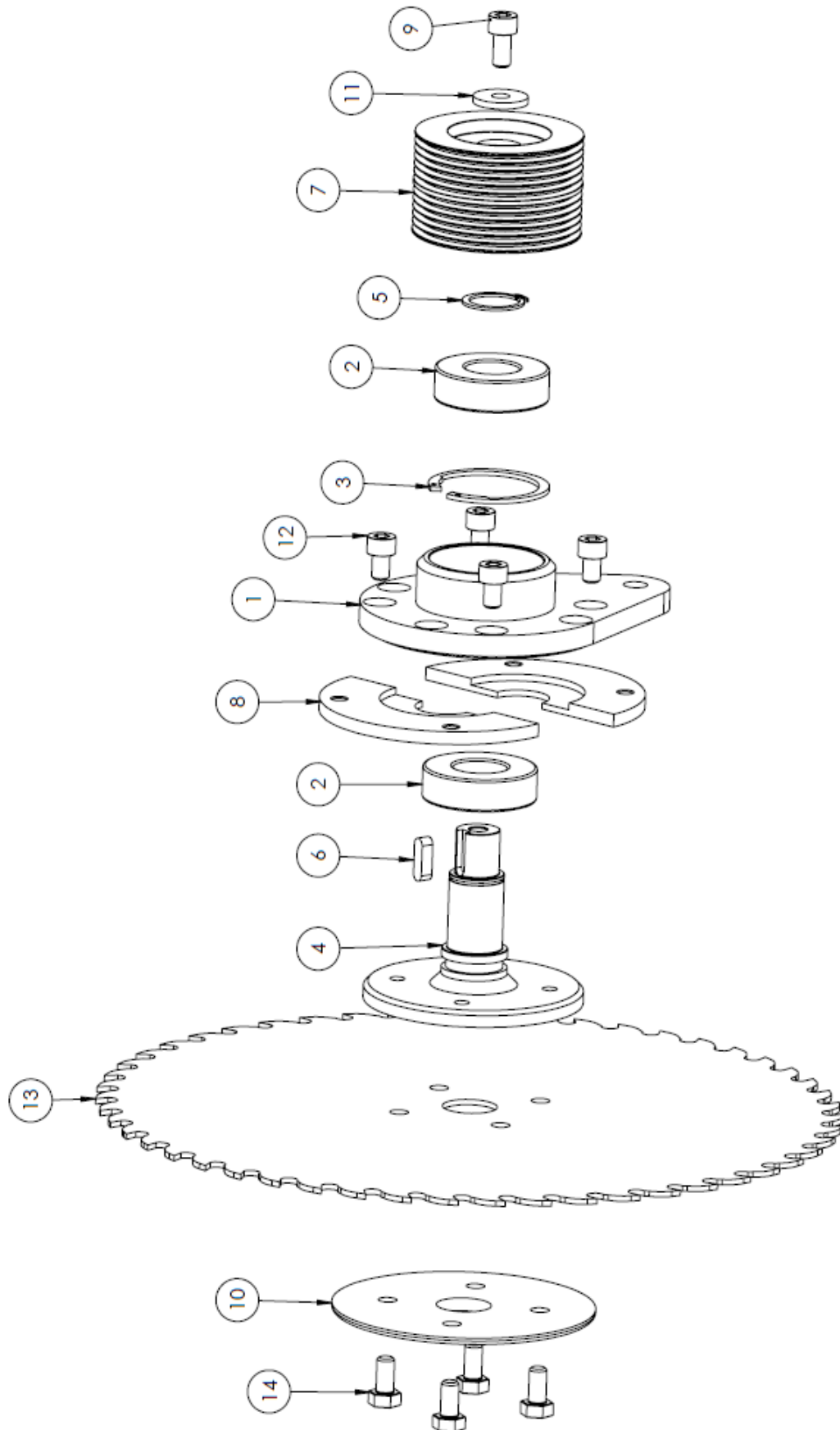









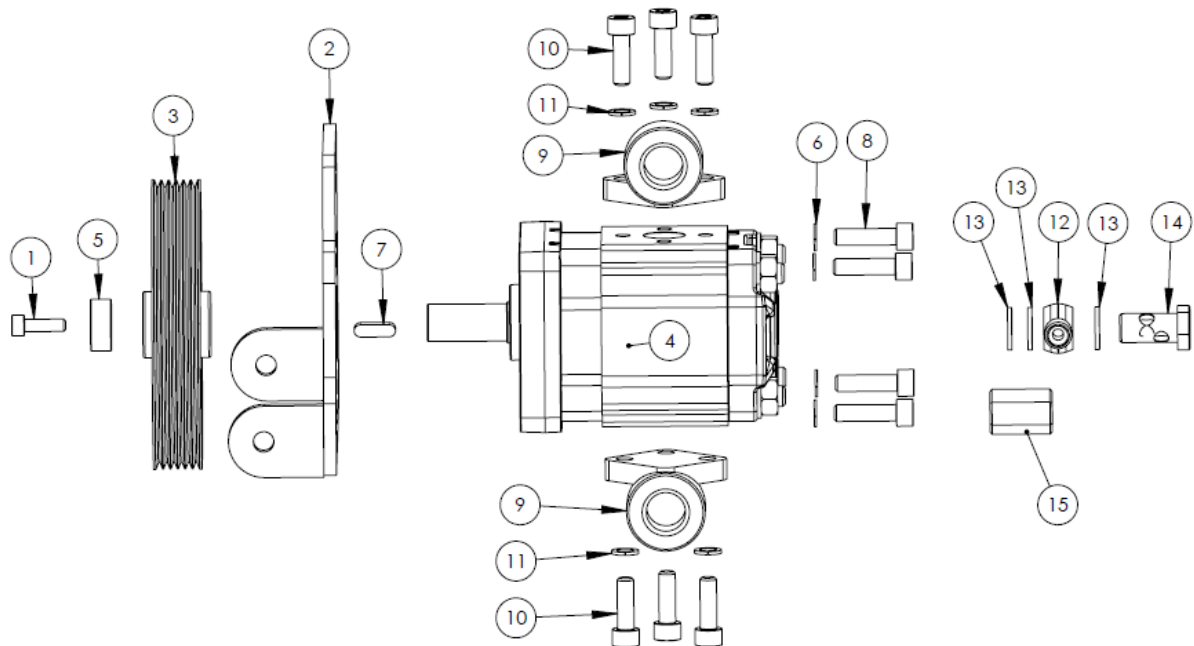



---

**Transmission „Blade“**

<b>Item</b>	<b>Qty.</b>	<b>Part no.</b>	<b>Description</b>
1	1	8141005	Bearing house
2	2	8144003	Bearing
3	1	8142005	Lock ring
4	1	8141006	Shaft
5	1	2771111	Lock ring
6	1	8144004	Key
7	1	8144005	Pulley
8	2	8141007	Half moon
9	1	8142008	Bolt
10	1	8141009	Mounting plate (outer) for Bolts.
11	1	200138	Washer HD M8
12	4	8142004	Bolt
13	1	140111.0	Blade 340 mm
Not shown	1	8148002	Belt test tool "Optikrik I" NOT SHOWN
14	4	8142008	Bolt

## Transmission Motor



Item	Qty.	Part no.	Description
1	1	8142009	Allen screw M6x12
2	1	8141014	Mounting plate
3	1	8144009	Pulley
4a	1	8143001	Motor 11,2 cc/rev  (logo on motor) GL
*4b	1	8143008	Motor 11,2cc/rev  (logo on motor) NY
Not shown	1	8143006	Sealkit for Motor
5	1	8141015	Bushing
6	4	200156.0	Washer
7	1	8144004	Key
8	4	8142012	Bolt
9a	2	8143002	Flange incl.bolt,seal,washer  (logo on motor)
*9b	2	8483002	Flange incl.bolt,seal,washer  (logo on motor)
10+11a	6	N/A	Use 8143002  (logo on motor)
*10+11b	6	N/A	Use 8483002  (logo on motor)
12a	1	8143004	Banjo  (logo on motor)
*12b	1	8173001	Banjo  (logo on motor)
13a	3	8143005	Seal washer  (logo on motor)
*13b	3	8173003	Seal washes  (logo on motor)
Not shown	1	81480	Belt test tool "Optikrik I" NOT SHOWN
14a	1	8143004	Banjo bolt  (logo on motor)
*14b	1	8173002	Banjo bolt  (logo on motor)
15	1	AI08LR1/4X	Nippel

## Belt Tensioner

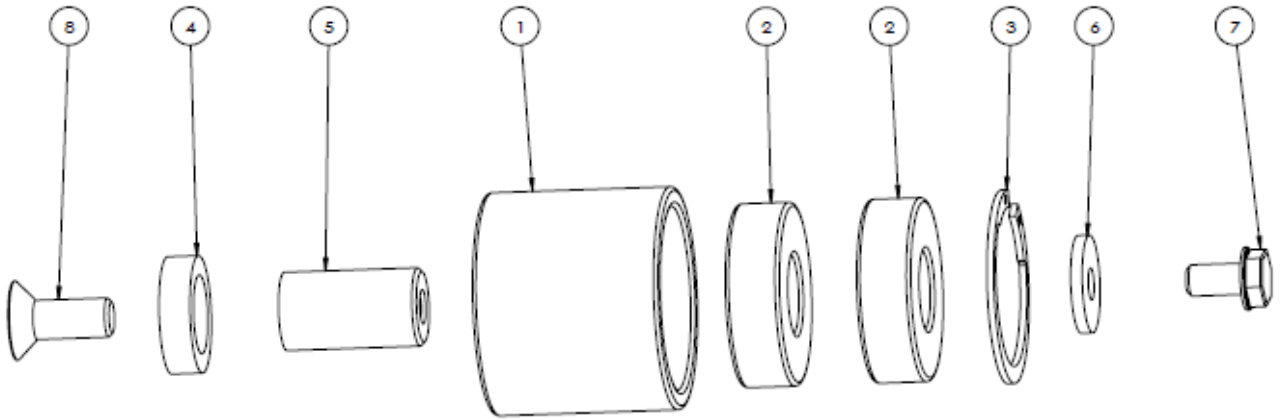

Item	Qty.	Part no.	Description
1	1	8141011	Tensioner
2	2	8144008	Bearing
3	1	8142010	Lockring
4	1	8141012	Washer
5	1	8141013	Shaft
6	1	200138	Washer HD M8
7	1	8142011	Bolt M8x16
8	1	8142013	US-Bolt M10x20

## Stickers



LRS1402 Klistermærke - 500 x 72 mm



LRS1402 advarselmærke1 - 173 x 107 mm



LRS1402 advarselmærke2 - 173 x 107 mm



GreenTec\_PEBuds mærke - 130 x 25 mm



Made in denmark - 50 x 18 mm

## LRS1402 KITS

Item	Qty.	Part no.	Description
1	1	Lrs1402kits	Sticker kit cpl.



Merkurvej 25 | DK-6000 Kolding | Tel.: +45 75 55 36 44 | [info@GreenTec.eu](mailto:info@GreenTec.eu) | [www.GreenTec.eu](http://www.GreenTec.eu)

*Cutting Edge Technology*